

MEMORY

LOW POWER SRAM CARD

PCMCIA Rel.2/JEIDA Ver.4 conformable

MB98A9083x/9093x/9103x/9113x-20

LOW POWER STATIC RANDOM ACCESS MEMORY CARD 256 K/512 K/1 M/2 M-BYTE

■ DESCRIPTION

The Fujitsu MB98A9083x, 9093x, 9103x and 9113x are Static Random Access Memory (SRAM) cards capable of storing and retrieving large amounts of data. The memory circuits are housed in a credit-card sized 68-pin package. Internal circuitry is protected by two metal panels, each one at the top and the bottom of the card, that help to reduce chip damage from electrostatic discharge.

When the SRAM card is not powered by its system, an on-board, replaceable lithium battery (coin-type) is used to retain data. When the lithium battery must be replaced, rechargeable battery that are built in the SRAM card, maintain data. (See the BLOCK DIAGRAM for location of batteries.)

A unique feature of the Fujitsu memory cards allows the user to organize the card into either an 8-bit or a 16-bit bus configuration. All cards are portable and operate on low power at high speed.

In accordance with the Personal Computer Memory Card International Association (PCMCIA) and Japan Electrical Industry Development Association (JEIDA) industry standard specifications, SRAM cards offer additional EEPROM memory that is used to store attribute data. The attribute memory is an SRAM card option. (See page 3 for a description of the three available options.)

- Credit card size: 85.6 mm (length) × 54.0 mm (width) × 3.3 mm (thick).
- PCMCIA/JEIDA conformed two-piece 68-pin connector (with a two-row built-in 68-pin receptacle)
- Low operating and standby power consumption
- Built-in, rechargeable batteries for data retention during lithium battery replacement
- Battery voltage detect and write protect function

■ PACKAGE

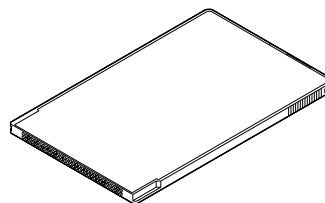

CRD-68P-M04

MB98A9083x/9093x/9103x/9113x-20

■ ATTRIBUTE MEMORY OPTIONS

PCMCIA and JEIDA standard memory cards from Fujitsu provide a separate EEPROM memory address space for recording fundamental card information. It is used by the card manufacturers to record basic configuration information such as device type, size, speed, etc.

The attribute memory is selected by asserting the $\overline{\text{REG}}$ pin on the card interface. Option descriptions as follows:

OPTION 1: Attribute memory is not supported. REG Pin: Not Contacted

(JEIDA Ver.3 conformable)

Part Number	Main Memory		Attribute Memory		Memory Organization*
	Memory Device	Access Time	Memory Device	Access Time	
MB98A90831	1M SRAM × 2 pcs	200 ns	—	—	256 K × 8 bits/128 K × 16 bits
MB98A90931	1M SRAM × 4 pcs	200 ns	—	—	512 K × 8 bits/256 K × 16 bits
MB98A91031	1M SRAM × 8 pcs	200 ns	—	—	1 M × 8 bits/512 K × 16 bits
MB98A91131	1M SRAM × 16 pcs	200 ns	—	—	2 M × 8 bits/1 M × 16 bits

OPTION 2: Attribute memory in a separate location is not supported.

When the $\overline{\text{REG}}$ line is asserted, “FF” is output to the data bus to indicate that attribute data may be stored in main memory.

(PCMCIA Rel.2/JEIDA Ver.4 conformable)

Part Number	Main Memory		Attribute Memory		Memory Organization*
	Memory Device	Access Time	Memory Device	Access Time	
MB98A90832	1M SRAM × 2 pcs	200 ns	—	—	256 K × 8 bits/128 K × 16 bits
MB98A90932	1M SRAM × 4 pcs	200 ns	—	—	512 K × 8 bits/256 K × 16 bits
MB98A91032	1M SRAM × 8 pcs	200 ns	—	—	1 M × 8 bits/512 K × 16 bits
MB98A91132	1M SRAM × 16 pcs	200 ns	—	—	2 M × 8 bits/1 M × 16 bits

OPTION 3: Attribute memory is supported. The data is stored in an 16K-bit EEPROM.

When the $\overline{\text{REG}}$ line is asserted, data stored in EEPROM is output to the data bus.

(PCMCIA Rel.2/JEIDA Ver.4 conformable)

Part Number	Main Memory		Attribute Memory		Memory Organization*
	Memory Device	Access Time	Memory Device	Access Time	
MB98A90833	1M SRAM × 2 pcs	200 ns	EEPROM × 1 pcs	300 ns	256 K × 8 bits/128 K × 16 bits
MB98A90933	1M SRAM × 4 pcs	200 ns	EEPROM × 1 pcs	300 ns	512 K × 8 bits/256 K × 16 bits
MB98A91033	1M SRAM × 8 pcs	200 ns	EEPROM × 1 pcs	300 ns	1 M × 8 bits/512 K × 16 bits
MB98A91133	1M SRAM × 16 pcs	200 ns	EEPROM × 1 pcs	300 ns	2 M × 8 bits/1 M × 16 bits

Note: * To be configured by user.

MB98A9083x/9093x/9103x/9113x-20

Fig. 1 - MB98A9083x/9093x/9103x/9113x BLOCK DIAGRAM

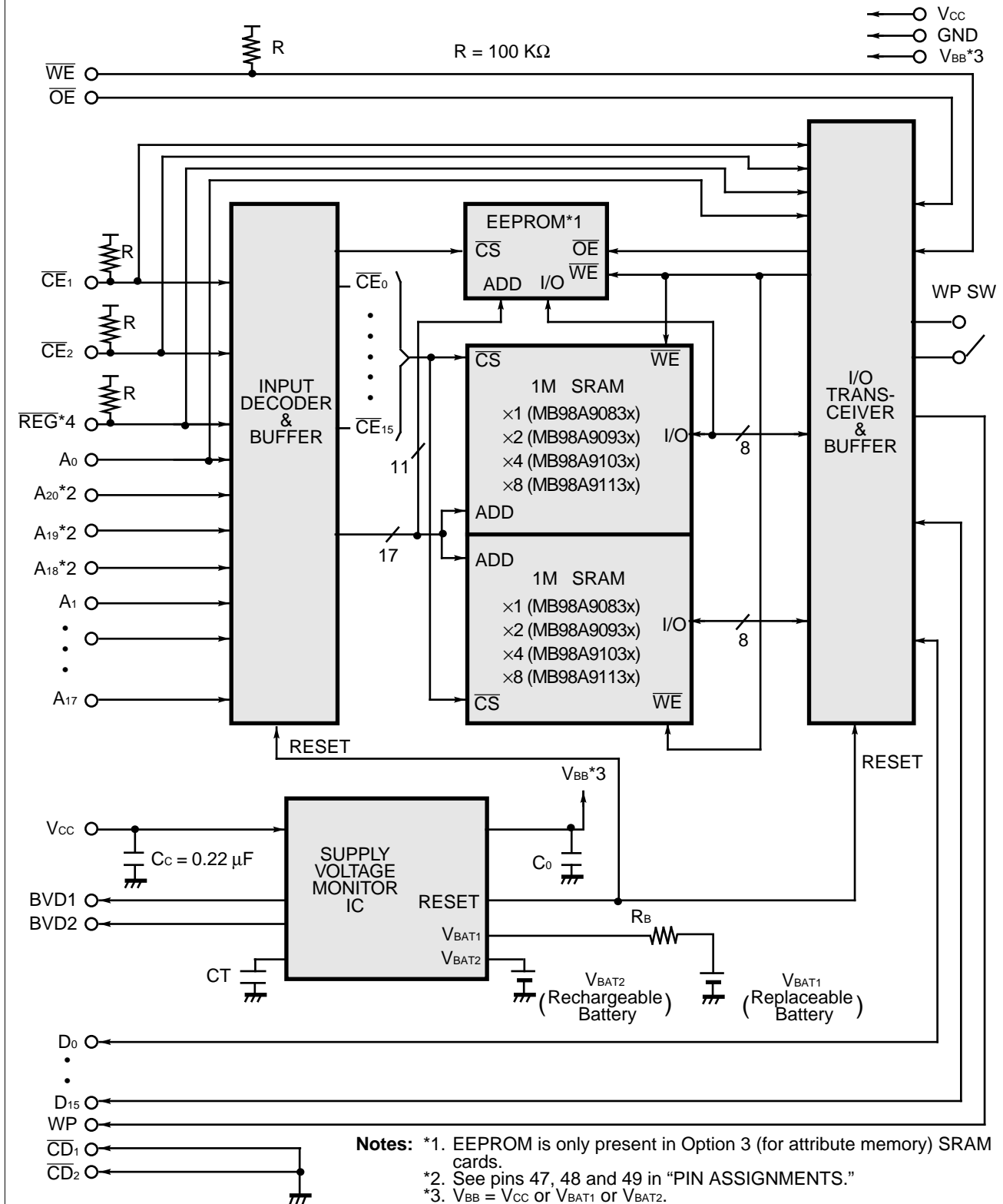

MB98A9083x/9093x/9103x/9113x-20

■ PIN ASSIGNMENTS

MB98A9083x	MB98A9093x	MB98A9103x	MB98A9113x	Pin No.		MB98A9083x	MB98A9093x	MB98A9103x	MB98A9113x
GND	GND	GND	GND	1	35	GND	GND	GND	GND
D ₃	D ₃	D ₃	D ₃	2	36	\overline{CD}_1	\overline{CD}_1	\overline{CD}_1	\overline{CD}_1
D ₄	D ₄	D ₄	D ₄	3	37	D ₁₁	D ₁₁	D ₁₁	D ₁₁
D ₅	D ₅	D ₅	D ₅	4	38	D ₁₂	D ₁₂	D ₁₂	D ₁₂
D ₆	D ₆	D ₆	D ₆	5	39	D ₁₃	D ₁₃	D ₁₃	D ₁₃
D ₇	D ₇	D ₇	D ₇	6	40	D ₁₄	D ₁₄	D ₁₄	D ₁₄
\overline{CE}_1	\overline{CE}_1	\overline{CE}_1	\overline{CE}_1	7	41	D ₁₅	D ₁₅	D ₁₅	D ₁₅
A ₁₀	A ₁₀	A ₁₀	A ₁₀	8	42	\overline{CE}_2	\overline{CE}_2	\overline{CE}_2	\overline{CE}_2
\overline{OE}	\overline{OE}	\overline{OE}	\overline{OE}	9	43	N.C.	N.C.	N.C.	N.C.
A ₁₁	A ₁₁	A ₁₁	A ₁₁	10	44	N.C.	N.C.	N.C.	N.C.
A ₉	A ₉	A ₉	A ₉	11	45	N.C.	N.C.	N.C.	N.C.
A ₈	A ₈	A ₈	A ₈	12	46	A ₁₇	A ₁₇	A ₁₇	A ₁₇
A ₁₃	A ₁₃	A ₁₃	A ₁₃	13	47	N.C.	A ₁₈	A ₁₈	A ₁₈
A ₁₄	A ₁₄	A ₁₄	A ₁₄	14	48	N.C.	N.C.	A ₁₉	A ₁₉
\overline{WE}	\overline{WE}	\overline{WE}	\overline{WE}	15	49	N.C.	N.C.	N.C.	A ₂₀
N.C.	N.C.	N.C.	N.C.	16	50	N.C.	N.C.	N.C.	N.C.
V _{CC}	V _{CC}	V _{CC}	V _{CC}	17	51	V _{CC}	V _{CC}	V _{CC}	V _{CC}
N.C.	N.C.	N.C.	N.C.	18	52	N.C.	N.C.	N.C.	N.C.
A ₁₆	A ₁₆	A ₁₆	A ₁₆	19	53	N.C.	N.C.	N.C.	N.C.
A ₁₅	A ₁₅	A ₁₅	A ₁₅	20	54	N.C.	N.C.	N.C.	N.C.
A ₁₂	A ₁₂	A ₁₂	A ₁₂	21	55	N.C.	N.C.	N.C.	N.C.
A ₇	A ₇	A ₇	A ₇	22	56	N.C.	N.C.	N.C.	N.C.
A ₆	A ₆	A ₆	A ₆	23	57	N.C.	N.C.	N.C.	N.C.
A ₅	A ₅	A ₅	A ₅	24	58	N.C.	N.C.	N.C.	N.C.
A ₄	A ₄	A ₄	A ₄	25	59	N.C.	N.C.	N.C.	N.C.
A ₃	A ₃	A ₃	A ₃	26	60	N.C.	N.C.	N.C.	N.C.
A ₂	A ₂	A ₂	A ₂	27	61	$\overline{REG}/N.C.*$	$\overline{REG}/N.C.*$	$\overline{REG}/N.C.*$	$\overline{REG}/N.C.*$
A ₁	A ₁	A ₁	A ₁	28	62	BVD2	BVD2	BVD2	BVD2
A ₀	A ₀	A ₀	A ₀	29	63	BVD1	BVD1	BVD1	BVD1
D ₀	D ₀	D ₀	D ₀	30	64	D ₈	D ₈	D ₈	D ₈
D ₁	D ₁	D ₁	D ₁	31	65	D ₉	D ₉	D ₉	D ₉
D ₂	D ₂	D ₂	D ₂	32	66	D ₁₀	D ₁₀	D ₁₀	D ₁₀
WP	WP	WP	WP	33	67	\overline{CD}_2	\overline{CD}_2	\overline{CD}_2	\overline{CD}_2
GND	GND	GND	GND	34	68	GND	GND	GND	GND

* : N.C. terminal in MB98A9XX31 series.

MB98A9083x/9093x/9103x/9113x-20

■ PIN DESCRIPTIONS

Symbol	Pin Name	Input/Output	Function
A ₀ to A ₂₀	Address Input	Input	Address Inputs, A ₀ to A ₂₀ .
D ₀ to D ₁₅	Data Input/Output	Input/Output	Data Inputs/Outputs. The data bus size (8-bit or 16-bit) selected with \overline{CE}_1 and \overline{CE}_2 .
\overline{CE}_1	Card Enable for Lower Byte	Input	Active Low – Lower byte (D ₀ to D ₇) is selected for read/write function of SRAM cards.
\overline{CE}_2	Card Enable for Upper Byte	Input	Active Low – Upper byte (D ₈ to D ₁₅) is selected for read/write function of SRAM cards.
\overline{REG}	Attribute Memory Select	Input	Active Low – Attribute memory is selected for read/write function of identification data of SRAM cards. (N.C. or “FF” data or attribute data.)
\overline{OE}	Output Enable	Input	Active Low – Output enable for SRAM cards.
\overline{WE}	Write Enable	Input	Active Low – Write enable for SRAM cards.
$\overline{CD}_1, \overline{CD}_2$	Card Detect	Output	These pins detect if the card has been correctly inserted. Both pins are tied to GND internally.
WP	Write Protect	Output	Write controller for SRAM cards This pin outputs the Protect / Non Protect status of “WP Switch”.
BVD1	Battery Voltage Detect 1	Output	These pins indicate the battery condition of the SRAM cards. a) BVD1 = BVD2 = V _{OH} – Battery voltage is a safe level. b) BVD2 = V _{OL} , BVD1 = V _{OH} – Battery voltage is lower than 2.65 V. Battery should be replaced. c) BVD1 = BVD2 = V _{OL} – Battery voltage is lower than 2.37 V, or battery is not present.
BVD2	Battery Voltage Detect 2	Output	
V _{cc}	Power Supply	—	Power Supply Voltage (+5.0 V±5%)
GND	Ground	—	System Ground
N.C.	No Connection	—	

■ PIN LOCATIONS

Fig. 2 – BOTTOM VIEW (CONNECTOR SIDE)

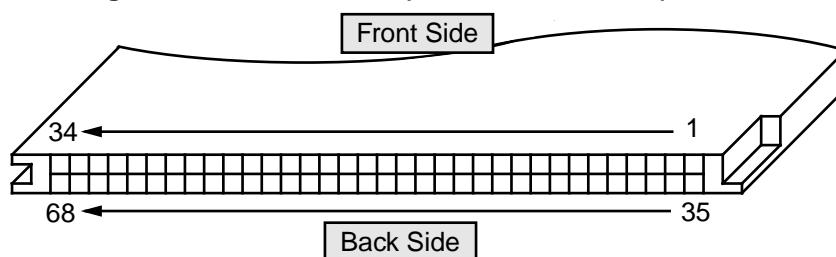

MB98A9083x/9093x/9103x/9113x-20

FUNCTIONAL TRUTH TABLE

MAIN MEMORY FUNCTION *1 ($\overline{\text{REG}} = V_{\text{IH}}$)

$\overline{\text{CE}}_2$	$\overline{\text{CE}}_1$	A_0 (Byte)	$\overline{\text{OE}}$	$\overline{\text{WE}}$	WP	Mode	Data Input/Output		WP SW
							D ₁₅ to D ₈	D ₇ to D ₀	
H	H	X	X	X	L	Standby	High-Z		NP
H	L	L	L	H	L	Read (×8)	High-Z	D _{OUT} (Lower Byte)	NP
H	L	H	L	H	L	Read (×8)	High-Z	D _{OUT} (Upper Byte)	NP
H	L	L	H*2	L	L	Write (×8)	High-Z	D _{IN} (Lower Byte)	NP
H	L	H	H*2	L	L	Write (×8)	High-Z	D _{IN} (Upper Byte)	NP
L	H	X	L	H	L	Read (×8)	D _{OUT} (Upper Byte)	High-Z	NP
L	H	X	H*2	L	L	Write (×8)	D _{IN} (Upper Byte)	High-Z	NP
L	L	X	L	H	L	Read (×16)	D _{OUT}		NP
L	L	X	H*2	L	L	Write (×16)	D _{IN}		NP
X	X	X	H	H	L	Output Disable	High-Z		NP

H	H	X	X	X	H	Standby	High-Z		P
H	L	L	L	H	H	Read (×8)	High-Z	D _{OUT} (Lower Byte)	P
H	L	H	L	H	H	Read (×8)	High-Z	D _{OUT} (Upper Byte)	P
H	L	L	H*2	L	H	Output Disable	High-Z		P
H	L	H	H*2	L	H	Output Disable	High-Z		P
L	H	X	L	H	H	Read (×8)	D _{OUT} (Upper Byte)	High-Z	P
L	H	X	H*2	L	H	Output Disable	High-Z		P
L	L	X	L	H	H	Read (×16)	D _{OUT}		P
L	L	X	H*2	L	H	Output Disable	High-Z		P
X	X	X	H	H	H	Output Disable	High-Z		P

Notes: *1. H = V_{IH}, L = V_{IL}, X = Either V_{IL} or V_{IH}, WP SW = Write Protect Switch, NP = Non Protect, P = Protect
*2. H-level is recommended though it is functionable at L-level.

MB98A9083x/9093x/9103x/9113x-20

ATTRIBUTE MEMORY FUNCTION *1 ($\overline{\text{REG}} = V_{\text{IL}}$) *2

$\overline{\text{CE}}_2$	$\overline{\text{CE}}_1$	A_0 (Byte)	$\overline{\text{OE}}$	$\overline{\text{WE}}$	WP	Mode	Data Input/Output		WP SW
							D ₁₅ to D ₈	D ₇ to D ₀	
H	H	X	X	X	L	Standby	High-Z		NP
H	L	L	L	H	L	Read (×8)	High-Z	D _{OUT} *3 (Lower Byte)	NP
H	L	H	L	H	L	Read (×8)	High-Z	H-level	NP
H	L	L	H	L	L	Write (×8)	High-Z	D _{IN} (Lower Byte)	NP
H	L	H	H	L	L	Write (×8)	High-Z	X	NP
L	H	X	L	H	L	Read (×8)	H-level	High-Z	NP
L	H	X	H	L	L	Write (×8)	High-Z	High-Z	NP
L	L	X	L	H	L	Read (×16)	H-level	D _{OUT} *3 (Lower Byte)	NP
L	L	X	H	L	L	Write (×16)	X	D _{IN} (Lower Byte)	NP
X	X	X	H	H	L	Output Disable	High-Z		NP

H	H	X	X	X	H	Standby	High-Z		P
H	L	L	L	H	H	Read (×8)	High-Z	D _{OUT} *3 (Lower Byte)	P
H	L	H	L	H	H	Read (×8)	High-Z	H-level	P
H	L	L	H	L	H	Output Disable	High-Z		P
H	L	H	H	L	H	Output Disable	High-Z		P
L	H	X	L	H	H	Read (×8)	H-level	High-Z	P
L	H	X	H	L	H	Output Disable	High-Z		P
L	L	X	L	H	H	Read (×16)	H-level	D _{OUT} *3 (Lower Byte)	P
L	L	X	H	L	H	Output Disable	High-Z		P
X	X	X	H	H	H	Output Disable	High-Z		P

Notes: *1. H = V_{IH} , L = V_{IL} , X = Either V_{IL} or V_{IH} , WP SW = Write Protect Switch, NP = Non Protect, P = Protect

*2. N.C. for MB98A90831, 90931, 91031 and 91131.

*3. H-level is output for MB98A90832, 90932, 91032 and 91132.

MB98A9083x/9093x/9103x/9113x-20

■ ADDRESS CONFIGURATIONS *1 (MAIN MEMORY)

8-BIT BUS ORGANIZATION ($\overline{CE}_1 = V_{IL}$, $\overline{CE}_2 = V_{IH}$)

A ₂₀ to A ₀						\overline{CE}_2	\overline{CE}_1	D ₁₅ to D ₈	D ₇ to D ₀
0	0000	0000	0000	0000	0000	H	L	-----	0 Add.
0	0000	0000	0000	0000	0001	H	L	-----	1 Add.
0	0000	0000	0000	0000	0010	H	L	-----	2 Add.
0	0000	0000	0000	0000	0011	H	L	-----	3 Add.
↓	↓	↓	↓	↓	↓	↓	↓	↓ ↓	↓ ↓
1	1111	1111	1111	1111	1100	H	L	-----	2,097,148 Add.
1	1111	1111	1111	1111	1101	H	L	-----	2,097,149 Add.
1	1111	1111	1111	1111	1110	H	L	-----	2,097,150 Add.
1	1111	1111	1111	1111	1111	H	L	-----	2,097,151 Add.

8-BIT BUS ORGANIZATION ($\overline{CE}_1 = V_{IH}$, $\overline{CE}_2 = V_{IL}$) *2

A ₂₀ to A ₀						\overline{CE}_2	\overline{CE}_1	D ₁₅ to D ₈	D ₇ to D ₀
0	0000	0000	0000	0000	000x	L	H	1 Add.	-----
0	0000	0000	0000	0000	001x	L	H	3 Add.	-----
0	0000	0000	0000	0000	010x	L	H	5 Add.	-----
0	0000	0000	0000	0000	011x	L	H	7 Add.	-----
↓	↓	↓	↓	↓	↓	↓	↓	↓ ↓	↓ ↓
1	1111	1111	1111	1111	100x	L	H	2,097,145 Add.	-----
1	1111	1111	1111	1111	101x	L	H	2,097,147 Add.	-----
1	1111	1111	1111	1111	110x	L	H	2,097,149 Add.	-----
1	1111	1111	1111	1111	111x	L	H	2,097,151 Add.	-----

16-BIT BUS ORGANIZATION ($\overline{CE}_1 = V_{IL}$, $\overline{CE}_2 = V_{IL}$)

A ₂₀ to A ₀						\overline{CE}_2	\overline{CE}_1	D ₁₅ to D ₈	D ₇ to D ₀
0	0000	0000	0000	0000	000x	L	L	1 Add.	0 Add.
0	0000	0000	0000	0000	001x	L	L	3 Add.	2 Add.
0	0000	0000	0000	0000	010x	L	L	5 Add.	4 Add.
0	0000	0000	0000	0000	011x	L	L	7 Add.	6 Add.
↓	↓	↓	↓	↓	↓	↓	↓	↓ ↓	↓ ↓
1	1111	1111	1111	1111	100x	L	L	2,097,145 Add.	2,097,144 Add.
1	1111	1111	1111	1111	101x	L	L	2,097,147 Add.	2,097,146 Add.
1	1111	1111	1111	1111	110x	L	L	2,097,149 Add.	2,097,148 Add.
1	1111	1111	1111	1111	111x	L	L	2,097,151 Add.	2,097,150 Add.

Notes: *1. H = V_{IH}, L = V_{IL}, X = Either 0 or 1.

*2. Even addresses are not available in this mode.

MB98A9083x/9093x/9103x/9113x-20

■ ABSOLUTE MAXIMUM RATINGS (See WARNING)

Parameter	Symbol	Value	Unit
Supply Voltage	V_{CC}	-0.5 to +6.0	V
Input Voltage	V_{IN}	-0.5 to $V_{CC} + 0.5$	V
Output Voltage	V_{OUT}	-0.5 to $V_{CC} + 0.5$	V
Ambient Temperature	T_A	-10 to +60 *1	°C
Storage Temperature	T_{STG}	-20 to +65 *2	°C

Notes: *1. This value does not apply to the replaceable battery.

*2. This value does not apply to the replaceable battery and data retention.

WARNING: Semiconductor devices can be permanently damaged by application of stress (voltage, current, temperature, etc.) in excess of absolute maximum ratings. Do not exceed these ratings.

■ RECOMMENDED OPERATING CONDITIONS

(Referenced to GND)

Parameter	Symbol	Min.	Typ.	Max.	Unit
Supply Voltage	V_{CC}	4.75	5.0	5.25	V
Ground	GND	—	0	—	V
Input High Voltage	V_{IH}	2.4	—	$V_{CC} + 0.3$	V
Input Low Voltage	V_{IL}	-0.3	—	0.8	V
Ambient Temperature *	T_A	0	—	55	°C

Note: * This value does not apply to the replaceable lithium battery. See V_{BAT1} in Fig.1.

WARNING: Recommended operating conditions are normal operating ranges for the semiconductor device. All the device's electrical characteristics are warranted when operated within these ranges.

Always use semiconductor devices within the recommended operating conditions. Operation outside these ranges may adversely affect reliability and could result in device failure.

No warranty is made with respect to uses, operating conditions, or combinations not represented on the data sheet. Users considering application outside the listed conditions are advised to contact their FUJITSU representative beforehand.

■ CAPACITANCE

($T_A = 25^\circ\text{C}$, $f = 1\text{ MHz}$, $V_{IN} = V_{I/O} = \text{GND}$)

Parameter	Notes	Symbol	Min.	Typ.	Max.	Unit
Input Capacitance	*1	C_{IN}	—	—	50	pF
I/O Capacitance	*2	$C_{I/O}$	—	—	50	pF

Notes: *1. This value does not apply to \overline{CE}_1 , \overline{CE}_2 , \overline{REG} and \overline{WE} .

*2. This value does not apply to \overline{BVD}_1 , \overline{BVD}_2 , \overline{CD}_1 and \overline{CD}_2 .

MB98A9083x/9093x/9103x/9113x-20

■ DC CHARACTERISTICS

(At recommended operating conditions unless otherwise noted.)

Parameter	Notes	Symbol	Condition	Min.	Typ.	Max.	Unit
Standby Supply Current	*1	I_{SB1}	$\overline{CE}_1, \overline{CE}_2 \geq V_{CC} - 0.2 \text{ V}$	—	—	0.5	mA
		I_{SB2}	$\overline{CE}_1, \overline{CE}_2 = V_{IH}$	—	—	5.0	mA
Active Supply Current		I_{CC1}	$V_{IN} = V_{IH} \text{ or } V_{IL}$ $\overline{CE}_1, \overline{CE}_2 = V_{IL}, I_{OUT} = 0 \text{ mA}$	—	—	50	mA
Operating Supply Current	MB98A9083x/9093x	I_{CC2}	$V_{IN} = V_{IH} \text{ or } V_{IL}$, Cycle = Min Duty = 100%, $I_{OUT} = 0 \text{ mA}$ $\overline{OE} = V_{IH}$ during Write Cycle	—	—	180	mA
	MB98A9103x/9113x			—	—	240	
Input Leakage Current	*2	I_{LI}	$V_{IN} = 0 \text{ V to } V_{CC}$	-10	—	10	μA
Output Leakage Current	*3	$I_{L/O}$	$V_{OUT} = 0 \text{ V to } V_{CC}$, $\overline{CE}_1, \overline{CE}_2 = V_{IH}$ or $\overline{OE} = V_{IH}$ or $\overline{WE} = V_{IL}$	-10	—	10	μA
Output High Voltage	*4	V_{OH}	$I_{OH} = -1.0 \text{ mA}$	2.4	—	—	V
Output Low Voltage		V_{OL}	$I_{OL} = 2.1 \text{ mA}$	—	—	0.4	V

Notes: *1. This value does not apply to recharge current from system or replaceable lithium battery to rechargeable battery.

*2. This value does not apply to \overline{CE}_1 , \overline{CE}_2 , \overline{REG} and \overline{WE} .

*3. This value does not apply to BVD1, BVD2, \overline{CD}_1 , \overline{CD}_2 and WP.

*4. This value does not apply to \overline{CD}_1 and \overline{CD}_2 .

Fig. 3 – AC TEST CONDITIONS

• Output Load

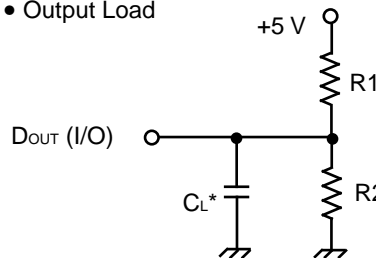

• Input Pulse Levels: 0.6 V to 2.6 V

• Input Pulse Rise and Fall Times: 5 ns (Transition between 0.8 V and 2.4 V)

• Timing Reference Levels

Input: $V_{IL} = 0.8 \text{ V}$, $V_{IH} = 2.4 \text{ V}$

Output: $V_{OL} = 0.8 \text{ V}$, $V_{OH} = 2.0 \text{ V}$

* Including Jig and stray capacitance

	R1	R2	CL	Parameters Mesured
Load I	1.8 k Ω	990 Ω	100 pF	All parameters except t_{CLZ} , t_{OLZ} , t_{CHZ} , t_{OHZ} , t_{RCLZ} , t_{ROLZ} , t_{RCHZ} , t_{ROHZ} , t_{WLZ} and t_{WHZ}
Load II	1.8 k Ω	990 Ω	5 pF	t_{CLZ} , t_{OLZ} , t_{CHZ} , t_{OHZ} , t_{RCLZ} , t_{ROLZ} , t_{RCHZ} , t_{ROHZ} , t_{WLZ} and t_{WHZ}

MB98A9083x/9093x/9103x/9113x-20

■ AC CHARACTERISTICS

(At recommended operating conditions unless otherwise noted.)

MAIN MEMORY READ CYCLE

Parameter	Notes	Symbol	Min.	Max.	Unit
Read Cycle Time		t _{RC}	200	—	ns
Address Access Time		t _{AA}	—	200	ns
Card Enable Access Time		t _{CE}	—	200	ns
Output Enable Access Time		t _{OE}	—	100	ns
Output Hold from Address Change		t _{OH}	5	—	ns
Card Enable to Output Low-Z	*1, 2	t _{CLZ}	5	—	ns
Output Enable to Output Low-Z	*1, 2	t _{OLZ}	5	—	ns
Card Enable to Output High-Z	*1, 2	t _{CHZ}	—	50	ns
Output Enable to Output High-Z	*1, 2	t _{OHZ}	—	50	ns

ATTRIBUTE MEMORY READ CYCLE *3

Parameter	Notes	Symbol	Min.	Max.	Unit
Read Cycle Time		t _{RRC}	300	—	ns
Address Access Time		t _{RAA}	—	300	ns
Card Enable Access Time		t _{RCE}	—	300	ns
Output Enable Access Time		t _{ROE}	—	150	ns
Output Hold from Address Change		t _{ROH}	5	—	ns
Card Enable to Output Low-Z	*1, 2	t _{RCLZ}	5	—	ns
Output Enable to Output Low-Z	*1, 2	t _{ROLZ}	5	—	ns
Card Enable to Output High-Z	*1, 2	t _{RCHZ}	—	60	ns
Output Enable to Output High-Z	*1, 2	t _{ROHZ}	—	60	ns

Notes: *1. Transition is measured at the point of ± 500 mV from steady state voltage.

*2. This parameter is specified using Load II in Fig.3.

*3. This parameter is for MB98A90833, 90933, 91033 and 91133.

MB98A9083x/9093x/9103x/9113x-20

MAIN MEMORY READ CYCLE TIMING DIAGRAM ($\overline{WE} = V_{IH}$, $\overline{REG} = V_{IH}$)

READ CYCLE 1: $\overline{CE}_1 = \overline{OE} = V_{IL}$, $\overline{CE}_2 = V_{IH}$: × 8-bit Bus Organization

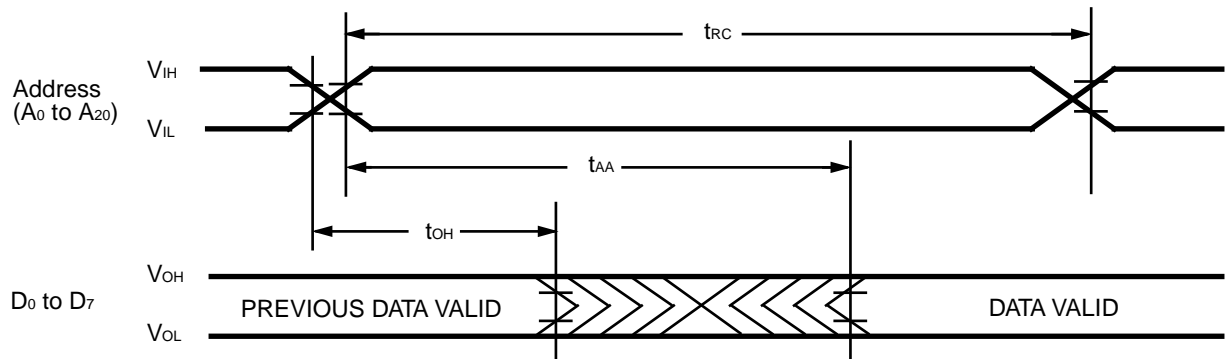

READ CYCLE 2: $\overline{CE}_1 = V_{IH}$, $\overline{CE}_2 = \overline{OE} = V_{IL}$: × 8-bit Bus Organization
 $\overline{CE}_1 = \overline{CE}_2 = \overline{OE} = V_{IL}$: × 16-bit Bus Organization

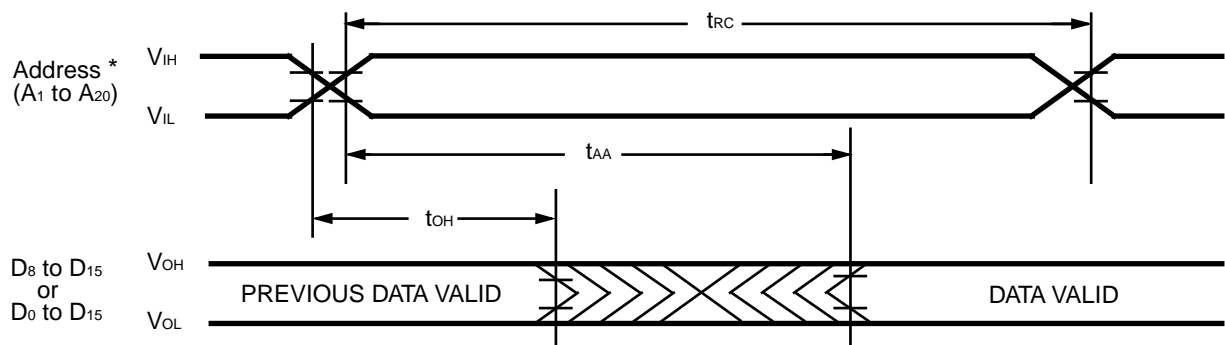

 : Undefined

Note: * A₀ = Either V_{IH} or V_{IL}.

MB98A9083x/9093x/9103x/9113x-20

MAIN MEMORY READ CYCLE TIMING DIAGRAM ($\overline{WE} = V_{IH}$, $\overline{REG} = V_{IH}$)

READ CYCLE 3: $\overline{CE}_2 = V_{IH}$: × 8-bit Bus Organization

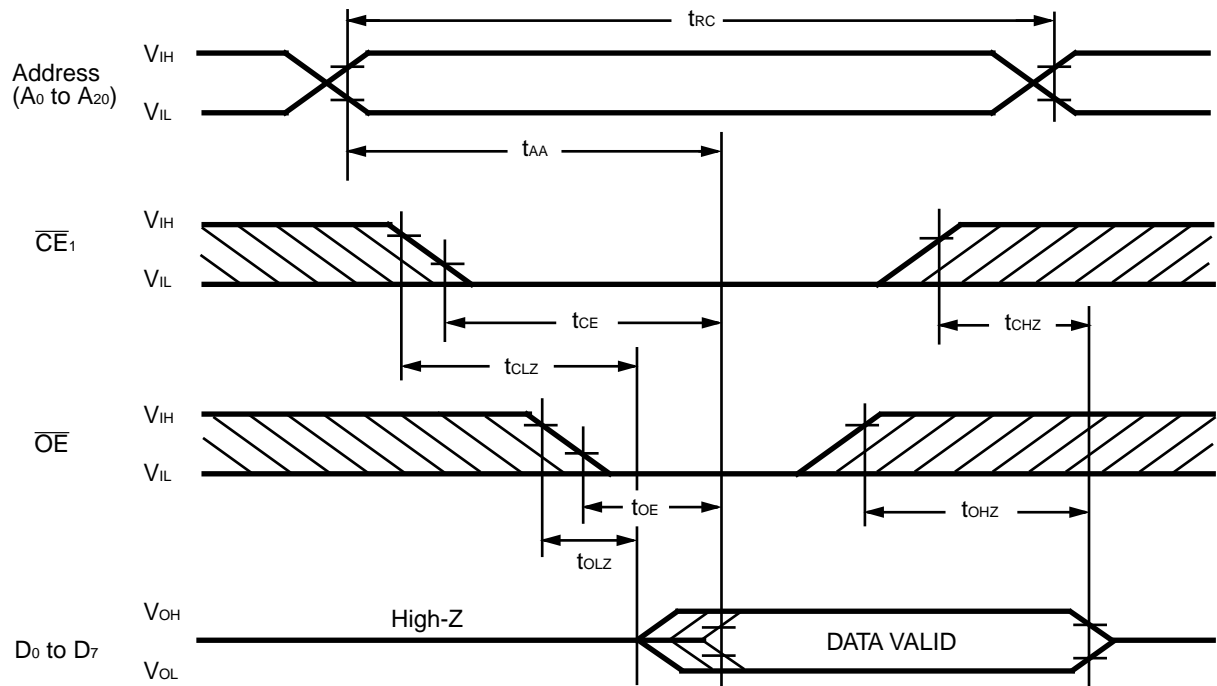

 : Undefined

MB98A9083x/9093x/9103x/9113x-20

MAIN MEMORY READ CYCLE TIMING DIAGRAM ($\overline{WE} = V_{IH}$, $\overline{REG} = V_{IH}$)

READ CYCLE 4: $\overline{CE}_1 = V_{IH}$: × 8-bit Bus Organization

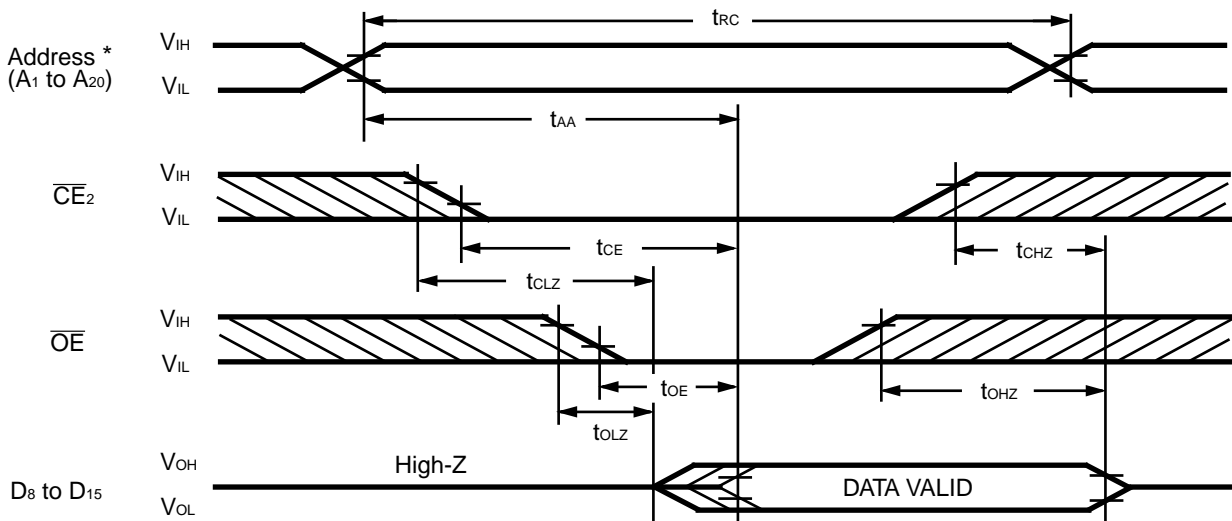

READ CYCLE 5: $\overline{CE}_1 = \overline{CE}_2$: × 16-bit Bus Organization

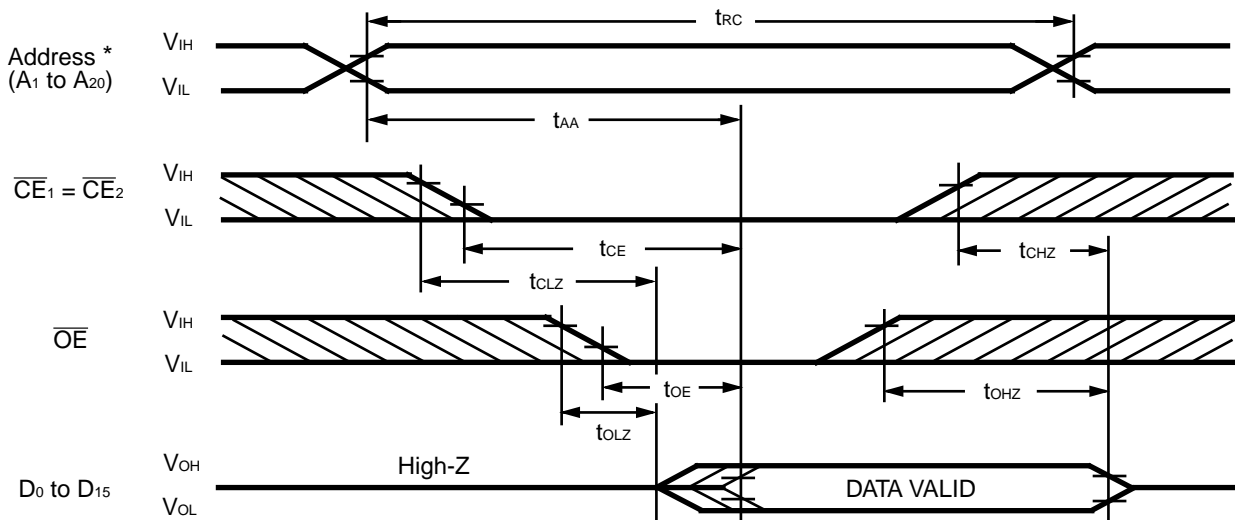

 : Undefined

Note: * A₀ = Either V_{IH} or V_{IL}.

MB98A9083x/9093x/9103x/9113x-20

ATTRIBUTE MEMORY READ CYCLE TIMING DIAGRAM ($\overline{WE} = V_{IH}$, $\overline{REG} = V_{IL}$) *1

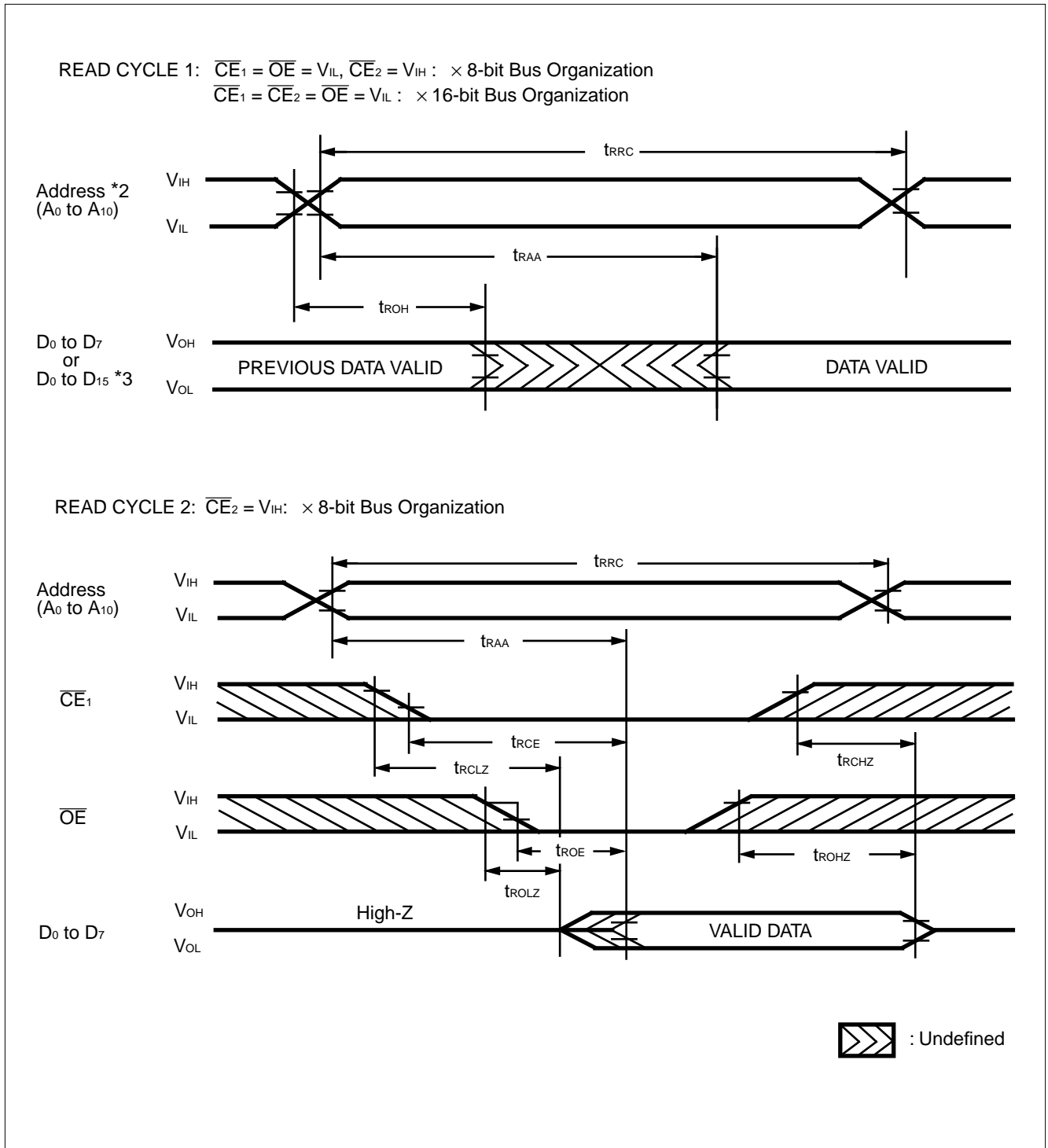

Notes: *1. This timing diagram is for MB98A90833, 90933, 91033 and 91133. "FF" data is available on MB98A90832, 90932, 91032, and 91132 only.

*2. A₀ = Either V_{IH} or V_{IL} for a 16-bit bus organization.

*3. H-level is output from D₈ to D₁₅.

MB98A9083x/9093x/9103x/9113x-20

ATTRIBUTE MEMORY READ CYCLE TIMING DIAGRAM ($\overline{WE} = V_{IH}$, $\overline{REG} = V_{IL}$) *1

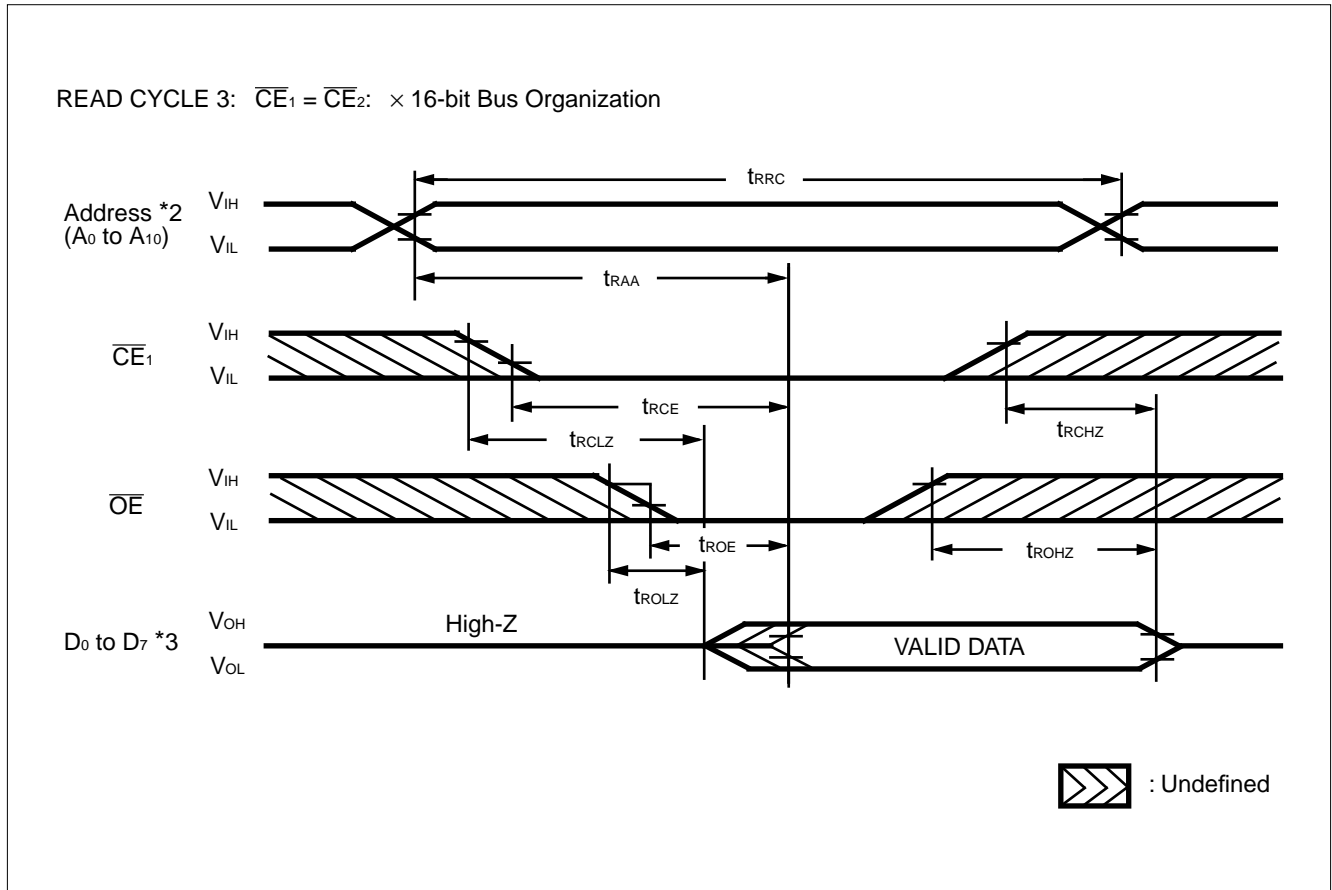

Notes: *1. This timing diagram is for MB98A90833, 90933, 91033, and 91133. "FF" data is available on MB98A90832, 90932, 91032, and 91132 only.

*2. A₀ = Either V_{IH} or V_{IL}.

*3. H-level is output from D₈ to D₁₅.

MB98A9083x/9093x/9103x/9113x-20

MAIN MEMORY WRITE CYCLE *1

Parameter	Notes	Symbol	Min.	Max.	Unit
Write Cycle Time		t _{WC}	200	—	ns
Address Valid to End of Write		t _{AW}	140	—	ns
Chip Select to End of Write		t _{CW}	140	—	ns
Data Valid to End of Write		t _{DW}	60	—	ns
Data Hold Time		t _{DH}	30	—	ns
Write Pulse Width		t _{WP}	120	—	ns
Address Set Up Time		t _{AS}	20	—	ns
Write Recovery Time		t _{WR}	30	—	ns
Output Enable to Output Low-Z	*2	t _{OLZ}	5	—	ns
Output Enable to Output High-Z	*2	t _{OHZ}	—	50	ns
Write Enable to Output Low-Z	*2, 3	t _{WLZ}	5	—	ns
Write Enable to Output High-Z	*2, 3	t _{WHZ}	—	50	ns
Output Enable Set Up Time		t _{OES}	10	—	ns
Output Enable Hold Time		t _{OEH}	10	—	ns

ATTRIBUTE MEMORY WRITE CYCLE *4

Parameter	Symbol	Min.	Max.	Unit
Byte Write Cycle Time	t _{RWR}	—	10	ms
Address Set Up Time	t _{RAS}	20	—	ns
Chip Enable Set Up Time	t _{RCS}	0	—	ns
Output Enable Set Up Time	t _{ROES}	20	—	ns
Write Pulse Width	t _{RWP}	100	—	ns
Address Hold Time	t _{RAH}	50	—	ns
Data Set Up Time	t _{RDS}	50	—	ns
Data Hold Time	t _{RDH}	20	—	ns
Chip Enable Hold Time	t _{RCH}	0	—	ns
Output Enable Hold Time	t _{ROEH}	20	—	ns
Write Recovery Time	t _{RRE}	50	—	ns
End of Write to Output Time	t _{RRBO}	—	100	ns
Number of Write per Byte	N	10000	—	Times
Write Enable Hold Time	t _{RWEH}	10	—	ns

Notes: *1. If \overline{OE} , \overline{CE}_1 , and \overline{CE}_2 are in the Read Mode during this period, then the I/O pins are in the output state and the input signals of the phase opposite to the outputs must be applied.

*2. Transition is measured at the point of ± 500 mV from steady state voltage.

*3. This parameter is specified only during write cycle with $\overline{OE} = V_{IL}$ and specified using Load II in Fig.3.

*4. This parameter is for MB98A90833, 90933, 91033 and 91133.

MB98A9083x/9093x/9103x/9113x-20

MAIN MEMORY WRITE CYCLE TIMING DIAGRAM ($\overline{WE} = \text{CONTROLLED}$, $\overline{REG} = V_{IH}$)

WRITE CYCLE 1: $\overline{CE}_2 = V_{IH}$: × 8-bit Bus Organization

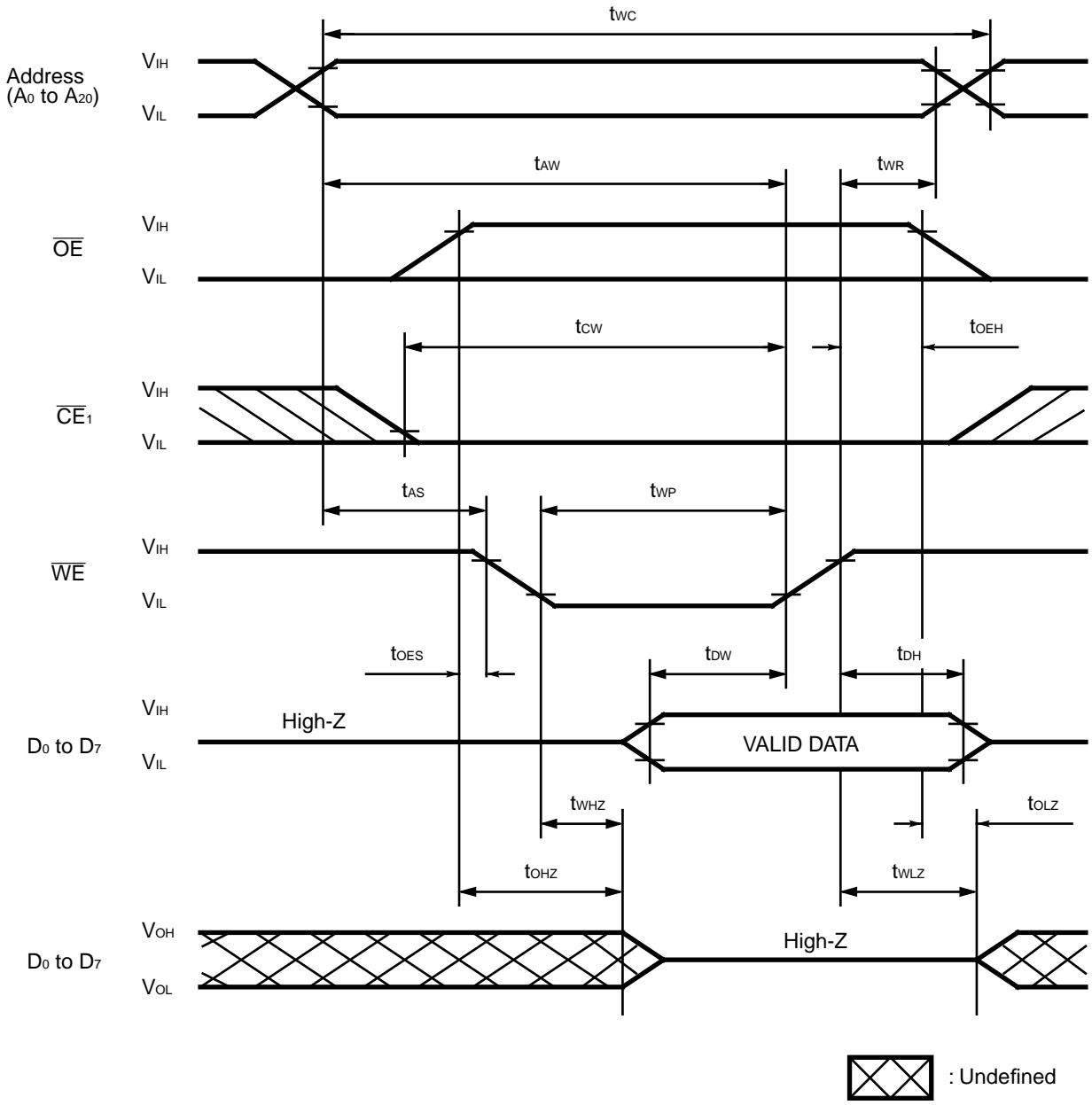

MB98A9083x/9093x/9103x/9113x-20

MAIN MEMORY WRITE CYCLE TIMING DIAGRAM ($\overline{WE} = \text{CONTROLLED}$, $\overline{REG} = V_{IH}$)

WRITE CYCLE 2: $\overline{CE}_1 = V_{IH}$: × 8-bit Bus Organization

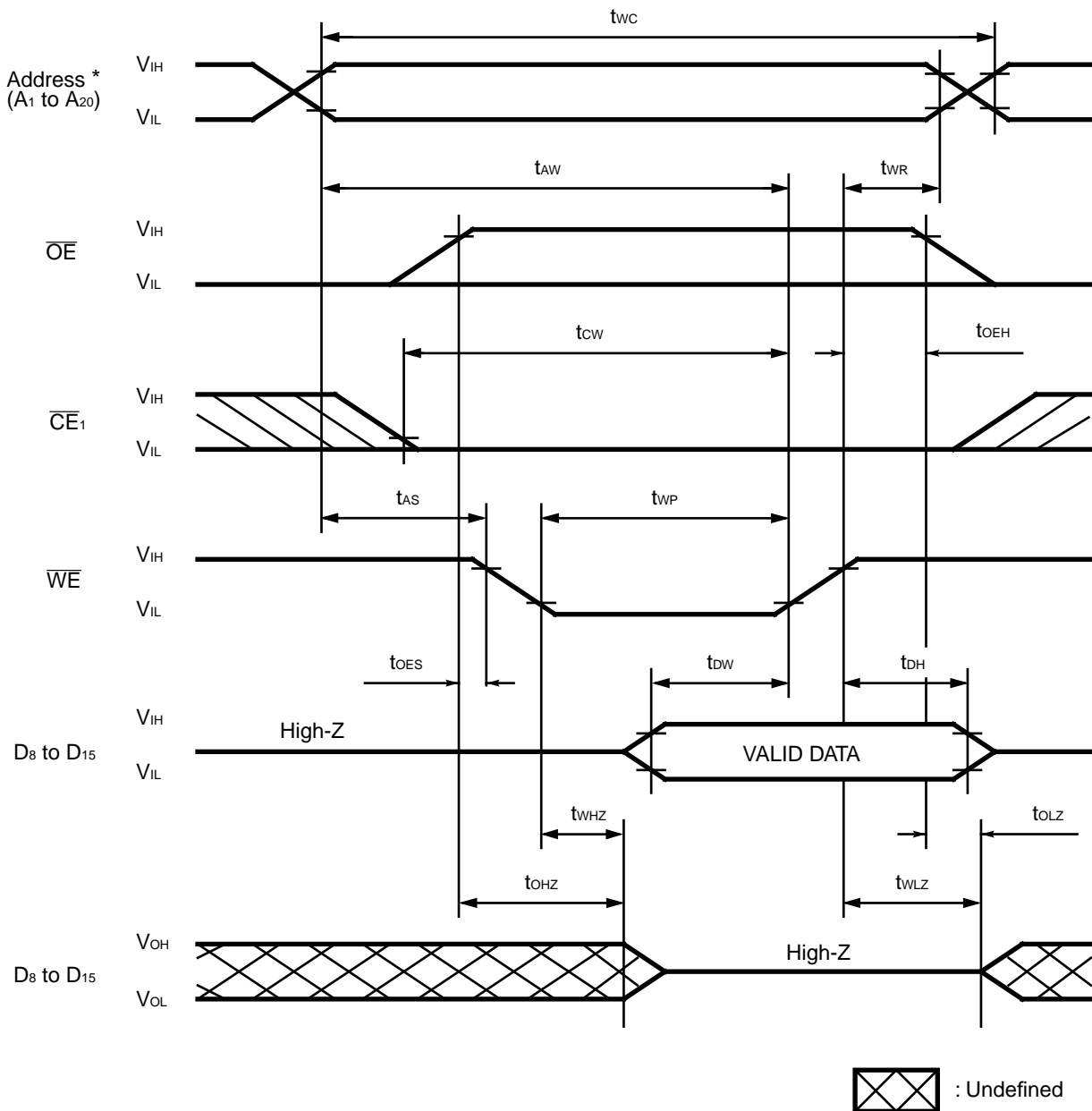

Note: * $A_0 = \text{Either } V_{IH} \text{ or } V_{IL}$.

MB98A9083x/9093x/9103x/9113x-20

MAIN MEMORY WRITE CYCLE TIMING DIAGRAM ($\overline{WE} = \text{CONTROLLED}$, $\overline{REG} = V_{IH}$)

WRITE CYCLE 3: $\overline{CE}_1 = \overline{CE}_2$: \times 16-bit Bus Organization

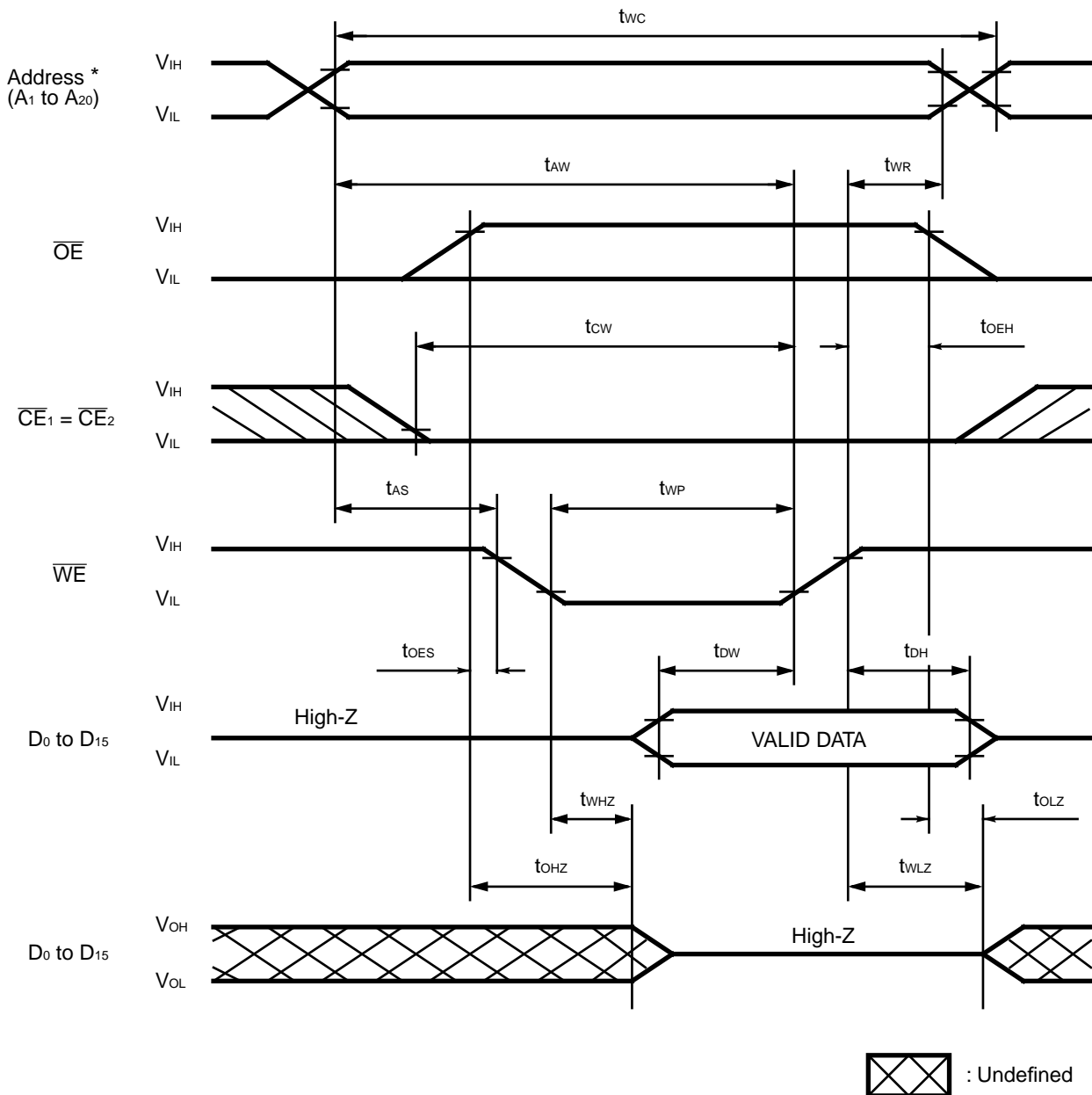

Note: * A₀ = Either V_{IH} or V_{IL} .

MB98A9083x/9093x/9103x/9113x-20

MAIN MEMORY WRITE CYCLE TIMING DIAGRAM ($\overline{CE} = \text{CONTROLLED}$, $\overline{REG} = V_{IH}$)

WRITE CYCLE 4: $\overline{CE}_2 = V_{IL}$: \times 8-bit Bus Organization

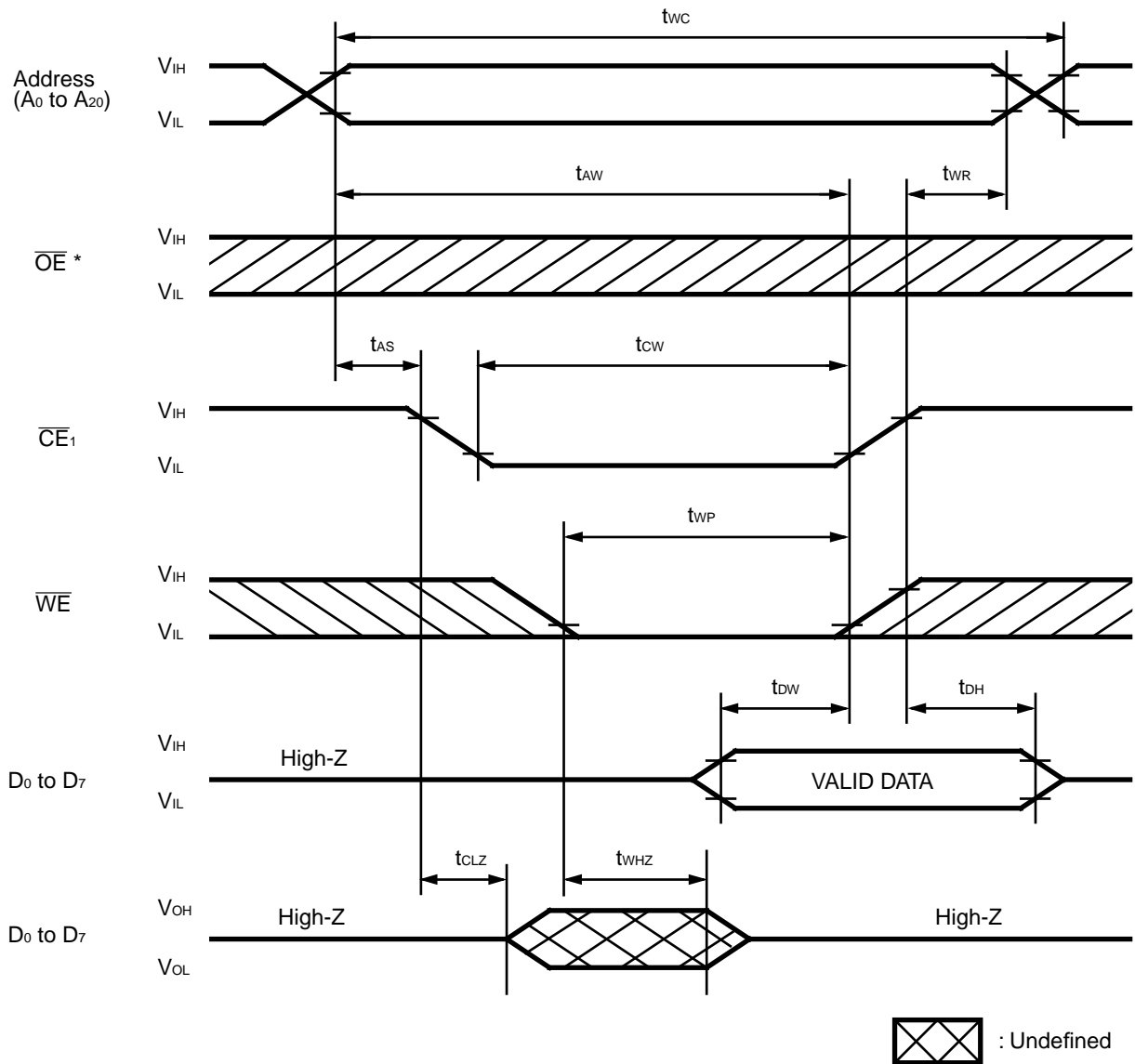

Note: * H-level is recommended for stable operation though the card is operable at L-level.

MB98A9083x/9093x/9103x/9113x-20

MAIN MEMORY WRITE CYCLE TIMING DIAGRAM ($\overline{CE} = \text{CONTROLLED}$, $\overline{REG} = V_{IH}$)

WRITE CYCLE 5: $\overline{CE}_1 = V_{IL}$: × 8-bit Bus Organization

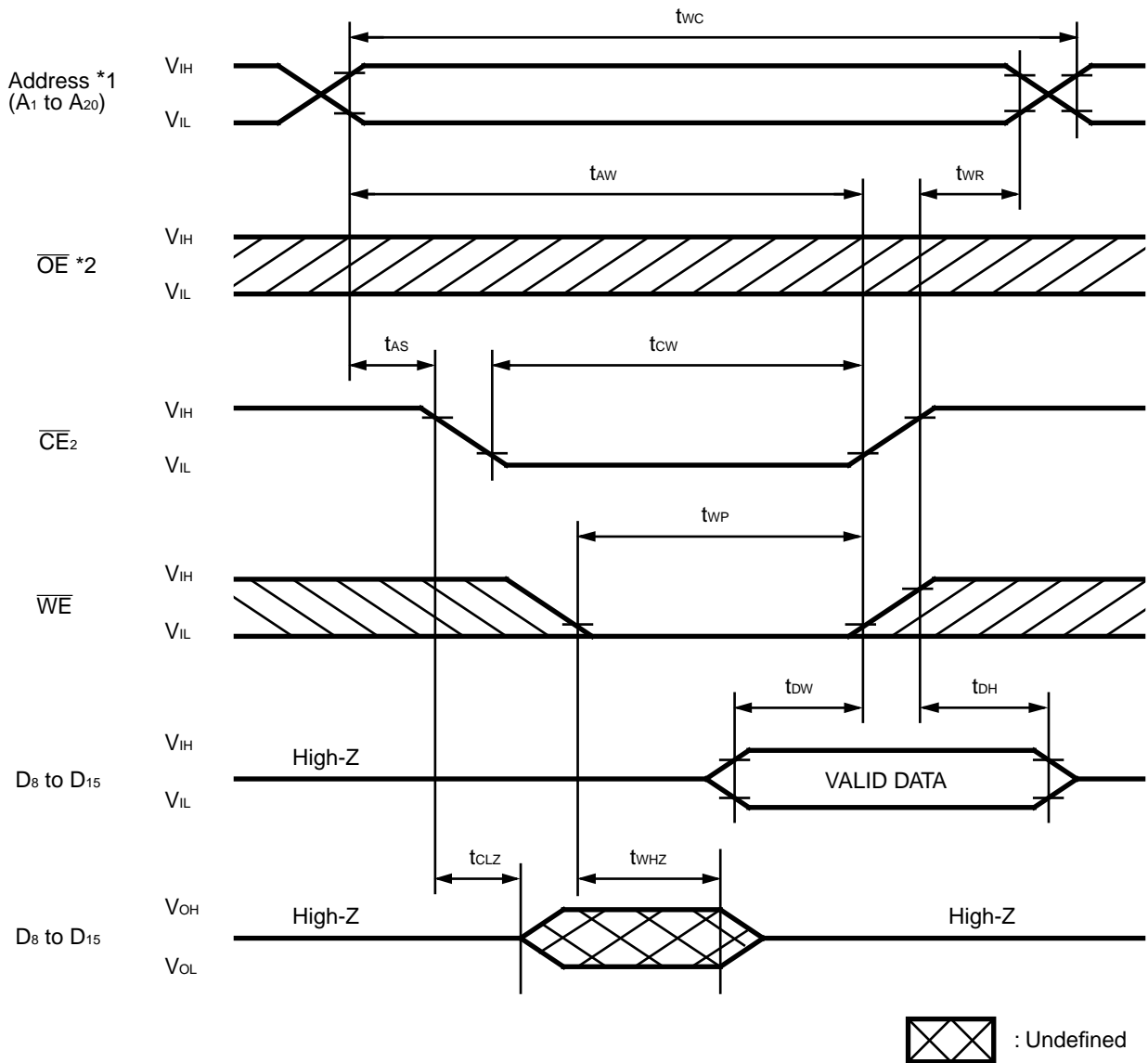

Notes: *1. A₀ = Either V_{IH} or V_{IL}.

*2. H-level is recommended for stable operation though the card is operable at L-level.

MB98A9083x/9093x/9103x/9113x-20

MAIN MEMORY WRITE CYCLE TIMING DIAGRAM (\overline{CE} = CONTROLLED, $\overline{REG} = V_{IH}$)

WRITE CYCLE 6: $\overline{CE}_1 = \overline{CE}_2$: × 16-bit Bus Organization

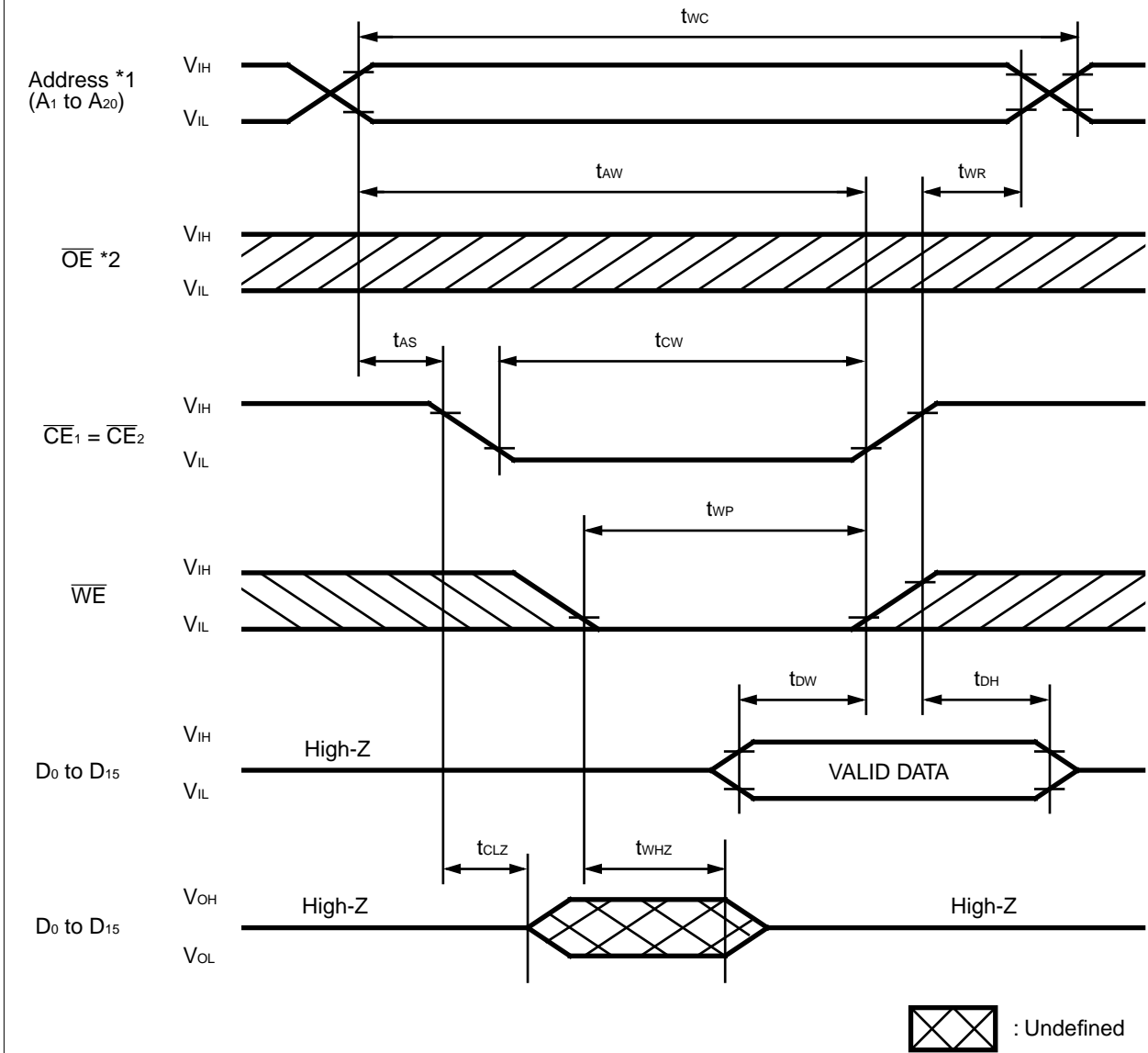

Notes: *1. A₀ = Either V_{IH} or V_{IL}.

*2. H-level is recommended for stable operation though the card is operable at L-level.

MB98A9083x/9093x/9103x/9113x-20

ATTRIBUTE MEMORY WRITE CYCLE TIMING DIAGRAM ($\overline{WE} = \text{CONTROLLED}$, $\overline{REG} = V_{IL}$) *1

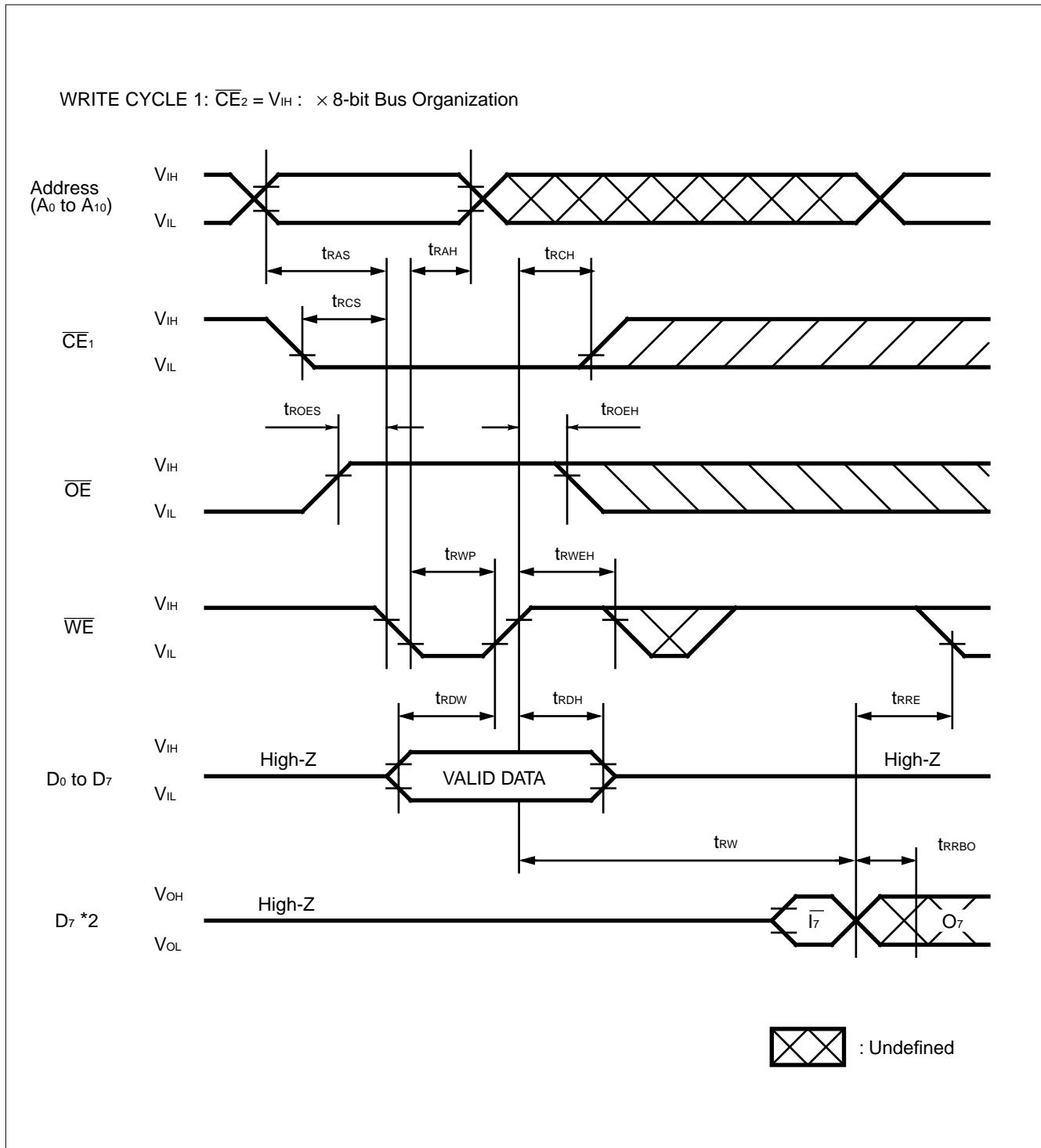

Notes: *1. This timing diagram is for MB98A90833, 90933, 91033, and 91133. "FF" data is available on MB98A90832, 90932, 91032, and 91132 only.

*2. Data polling operation.

MB98A9083x/9093x/9103x/9113x-20

ATTRIBUTE MEMORY WRITE CYCLE TIMING DIAGRAM (\overline{WE} = CONTROLLED, \overline{REG} = V_{IL}) *1

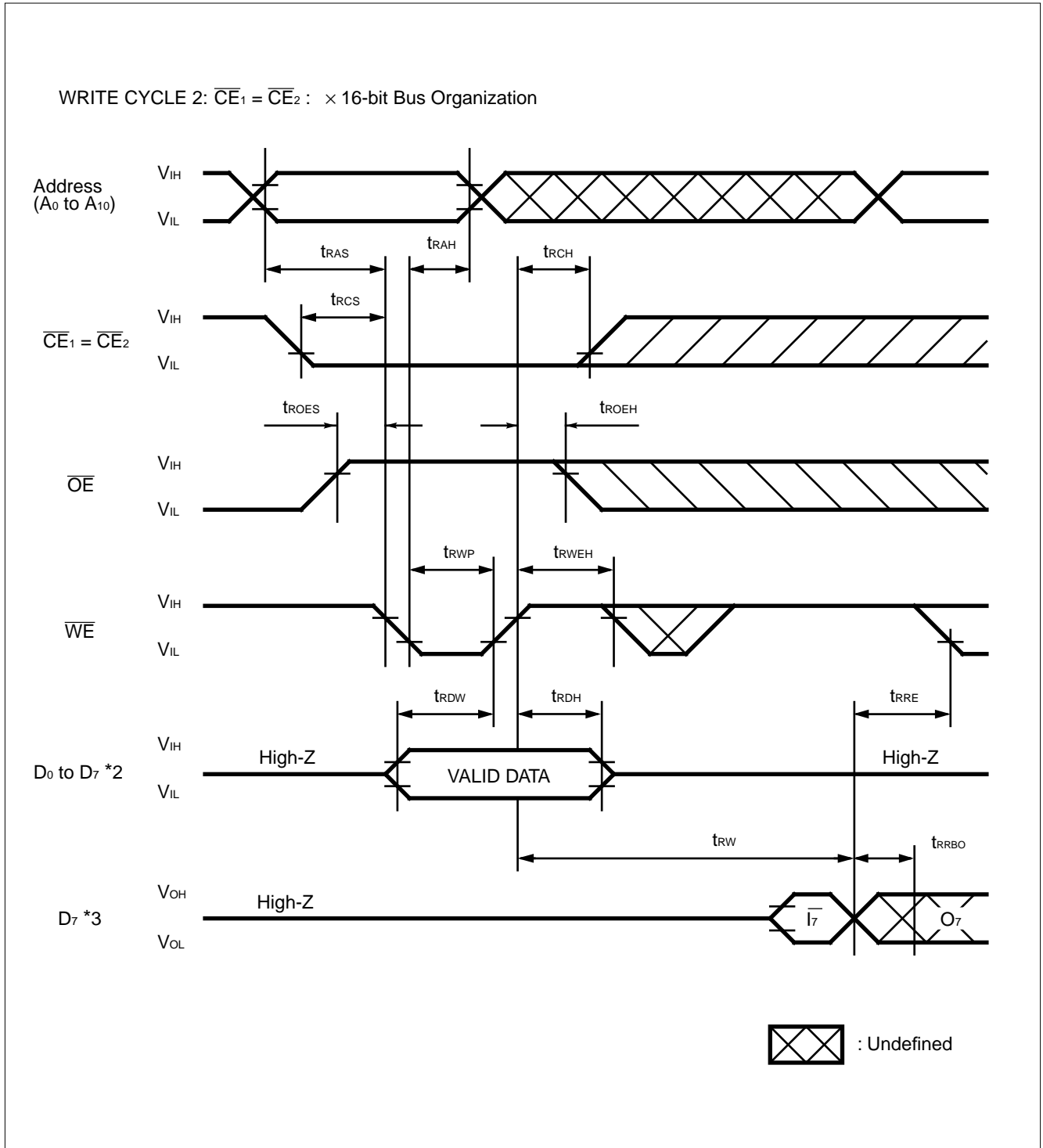

Notes: *1. This timing diagram is for MB98A90833, 90933, 91033, and 91133. "FF" data is available on MB98A90832, 90932, 91032, and 91132 only.

*2. Input levels of terminals D_8 to D_{15} are not specified.

*3. Data polling operation.

MB98A9083x/9093x/9103x/9113x-20

ATTRIBUTE MEMORY WRITE CYCLE TIMING DIAGRAM ($\overline{CE} = \text{CONTROLLED}$, $\overline{REG} = V_{IL}$) *1

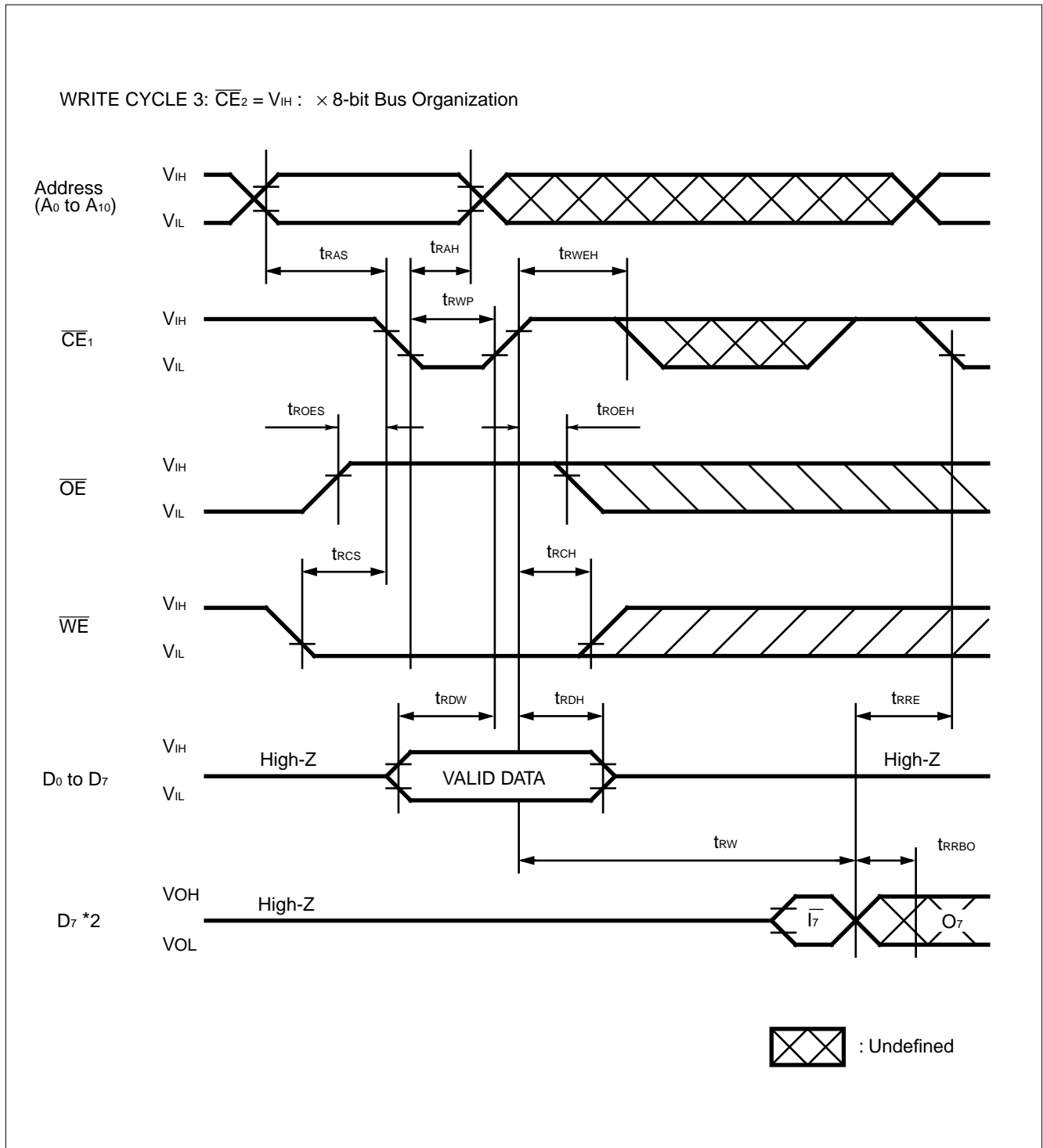

Notes: *1. This timing diagram is for MB98A90833, 90933, 91033, and 91133. "FF" data is available on MB98A90832, 90932, 91032, and 91132 only.

*2. Data polling operation.

MB98A9083x/9093x/9103x/9113x-20

ATTRIBUTE MEMORY WRITE CYCLE TIMING DIAGRAM ($\overline{CE} = \text{CONTROLLED}$, $\overline{REG} = V_{IL}$) *1

WRITE CYCLE 4: $\overline{CE}_1 = \overline{CE}_2$: × 16-bit Bus Organization

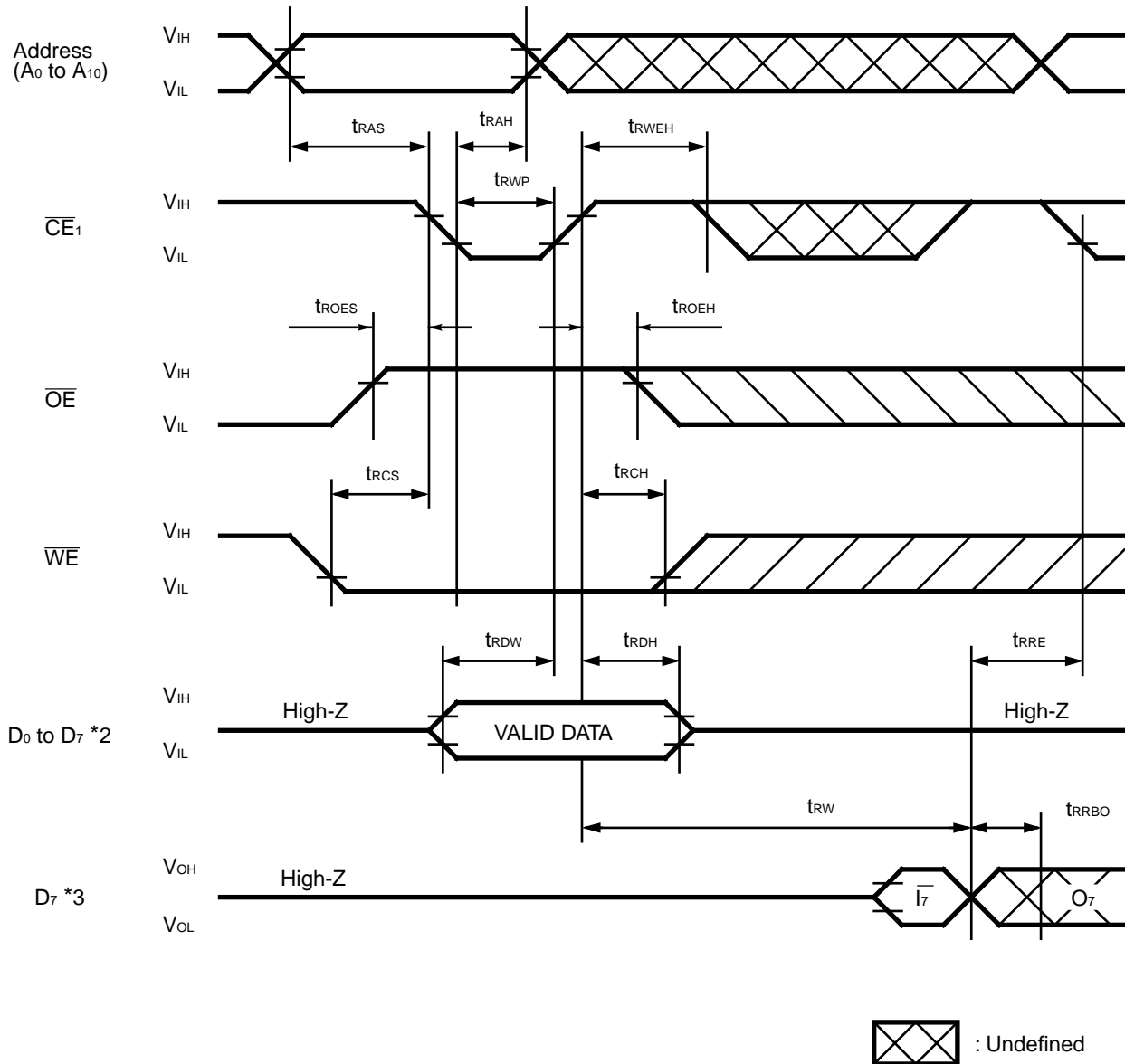

Notes: *1. This timing diagram is for MB98A90833, 90933, 91033, and 91133. "FF" data is available on MB98A90832, 90932, 91032, and 91132 only.

*2. Input levels of terminals D₈ to D₁₅ are not specified.

*3. Data polling operation.

MB98A9083x/9093x/9103x/9113x-20

■ POWER SUPPLY SEQUENCE CHARACTERISTICS

Parameter	Symbol	Min.	Typ.	Max.	Unit
Detection Rising Voltage	V_{INH}	4.2	4.3	4.4	V
Detection Falling Voltage	V_{INL}	4.1	4.2	4.3	V
Battery Backup Recovery Time	t_{BR}	3.0	—	—	ms
Data Retention Rising Time	t_{DRSU}	—	—	0.5	ms
Battery Backup Set Up Time	t_{BS}	10	—	—	μ s
Data Retention Falling Time	t_{DRSF}	0	—	—	ns

POWER-ON TIMING DIAGRAM

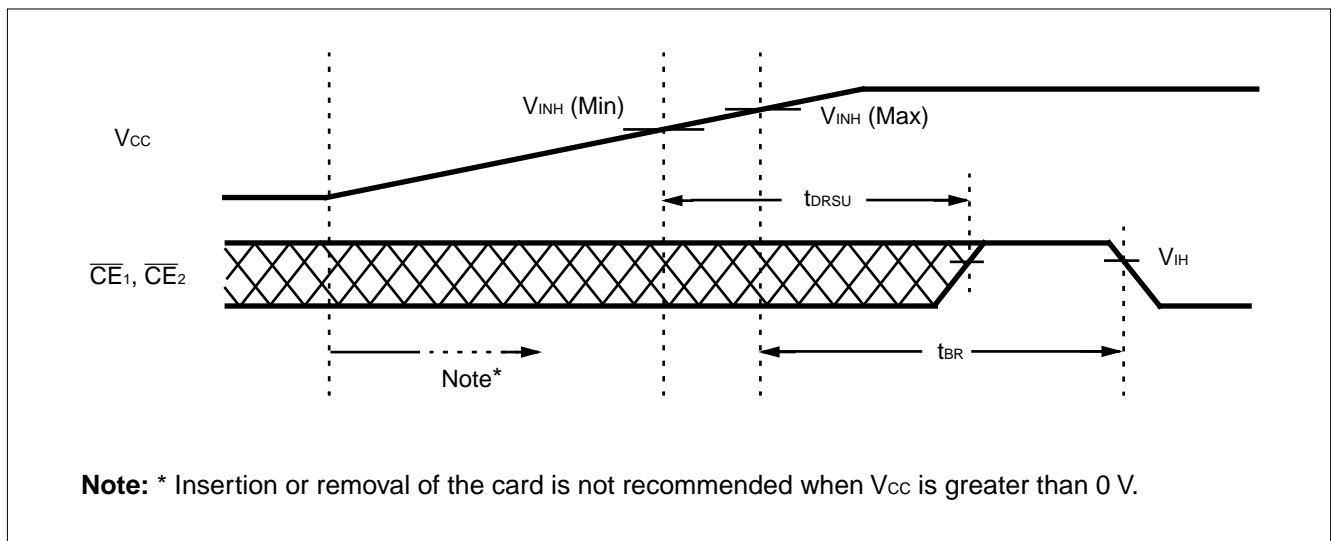

POWER-OFF TIMING DIAGRAM

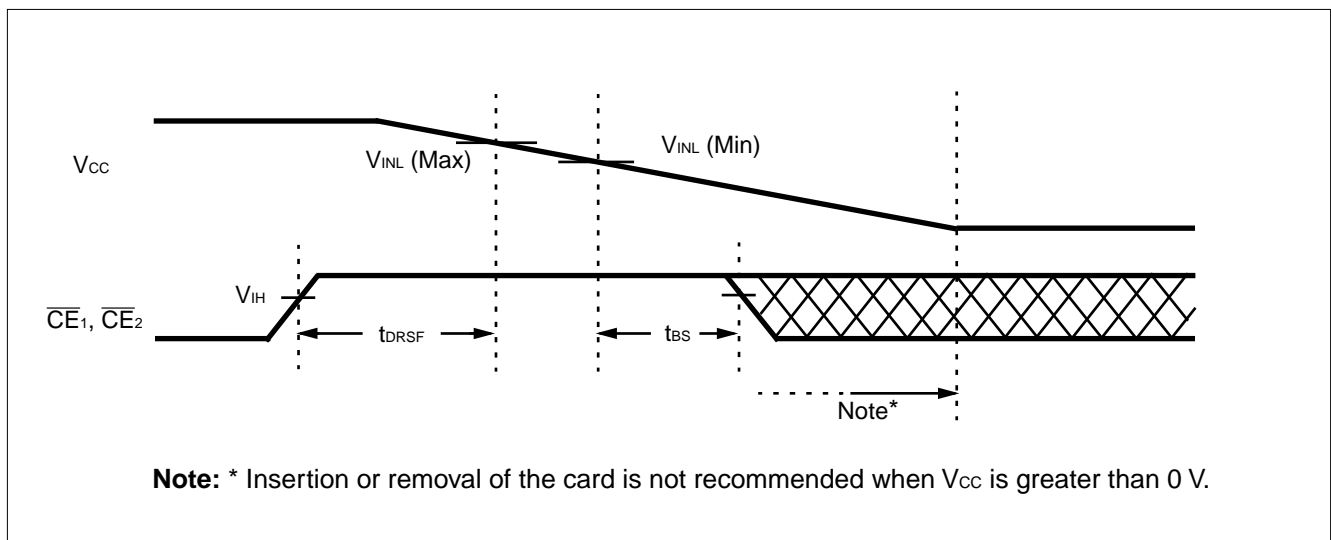

MB98A9083x/9093x/9103x/9113x-20

■ UNIQUE FEATURES FOR SRAM CARD

1. REPLACEABLE BATTERIES FOR THE SRAM CARD

The battery used in the SRAM Card is a 3.0 V Lithium battery (coin type) with the following specifications:

Diameter	: 20.0 (mm)
Thickness	: 2.5 (mm)
Weight	: 2.5 (g) Approx.
Type	: CR2025, or equivalent

2. APPROXIMATE DATA RETENTION TIME WITH BATTERY SUPPORT ONLY

Part Number	Approx. Data Retention Time * ($T_A = 20^\circ\text{C}$)
MB98A9083x	7 years min. 15 years typ.
MB98A9093x	4 years min. 8 years typ.
MB98A9103x	2 years min. 4 years typ.
MB98A9113x	1 year min. 2 years typ.

* Determined by the memory density of the card;
i.e., greater card density means less battery time.

3. REPLACING THE BATTERY IN THE SRAM CARD

- Insert a slender pointed object, such as the end of a paper clip, into the hole on the upper side of the card. (See Fig. 4.)
- Release the battery holder by pressing the paper clip against the catch and pulling the battery holder straight out from the card. (The battery cavity is located at the top of the card. See Fig. 5.) When the battery holder is free from the card the battery will fall out.
- Replace the old battery with a fresh one. Be certain to match battery polarity to the + and – shown on the holder.
- Place the new battery into the holder, squeeze the holder containing the new battery tightly, and reinsert it into the battery cavity.

WARNING

Battery **MUST** be replaced within 30 minutes* or data will be lost.

Note: *With condition that the SRAM card had been inserted into application system more than 10 minutes.

Fig. 4 – SRAM CARD DRAWING (TOP VIEW)

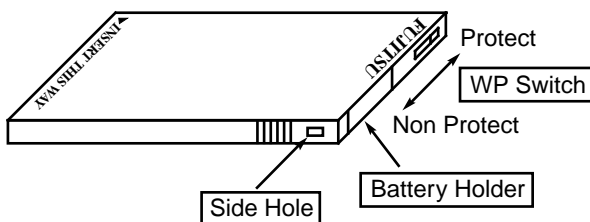
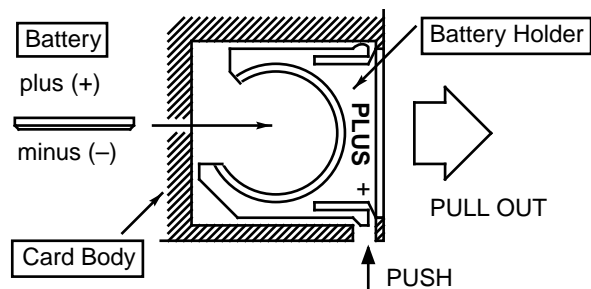

Fig.5 – BATTERY CASE DRAWING (TOP VIEW)



MB98A9083x/9093x/9103x/9113x-20

4. SPECIAL MONITORING PINS

4.1 BVD1, BVD2: Voltage Monitoring Pins

These pins monitor the voltage of the battery which must be maintained at 2.65 V or greater for data retention. The condition of the battery is determined by reading the output signals on BVD1 and BVD2.

1. When $BVD1=BVD2=V_{OH}$
Battery voltage is sufficient to guarantee data retention; i.e., 2.65 V.
2. When $BVD2=V_{OL}$, $BVD1=V_{OH}$
Battery voltage is lower than 2.65 V and should be replaced to safeguard data.
3. When $BVD1=BVD2=V_{OL}$
Battery voltage is less than 2.37 V: the level is dangerous. There is a possibility that data has not retained.

*These functions operate over the Recommended Operating Conditions.

4.2 \overline{CD}_1 , \overline{CD}_2 : Card Detection Pins

These pins detect the insertion of the card into the system.
(See Fig. 6.)

When the memory card has been correctly inserted, \overline{CD}_1 and \overline{CD}_2 are detected by the system. \overline{CD}_1 , \overline{CD}_2 are tied to ground on the card side as shown in Fig. 6.

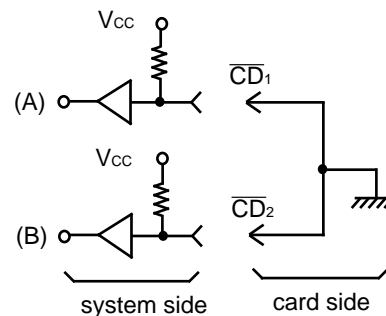

- Fig. 6 -

4.3 WP: Write Protect Pins

This pin monitors the position of the Write Protect switch. As shown in Fig. 7, the SRAM card has a Write Protect switch at the top of the card.

To write to the card, the switch must be turned to the "Non Protect" position and the WE pin low. L-level is output on the WP pin.

To prevent writing to the card, the switch must be turned to the "Protect" position. H-level is output on the WP pin.

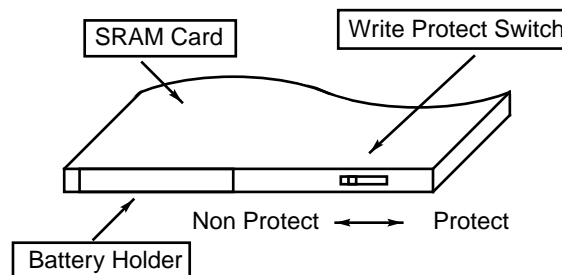

- Fig. 7 -

WP Switch	WP Pin
Protect	H
Non Protect	L

MB98A9083x/9093x/9103x/9113x-20

■ PACKAGE DIMENSIONS

68-PIN MEMORY CARD
(CASE No.: CRD-68P-M04)

Note: Dimensions conform with PCMCIA/JEIDA. (PC CARD STANDARD 95)

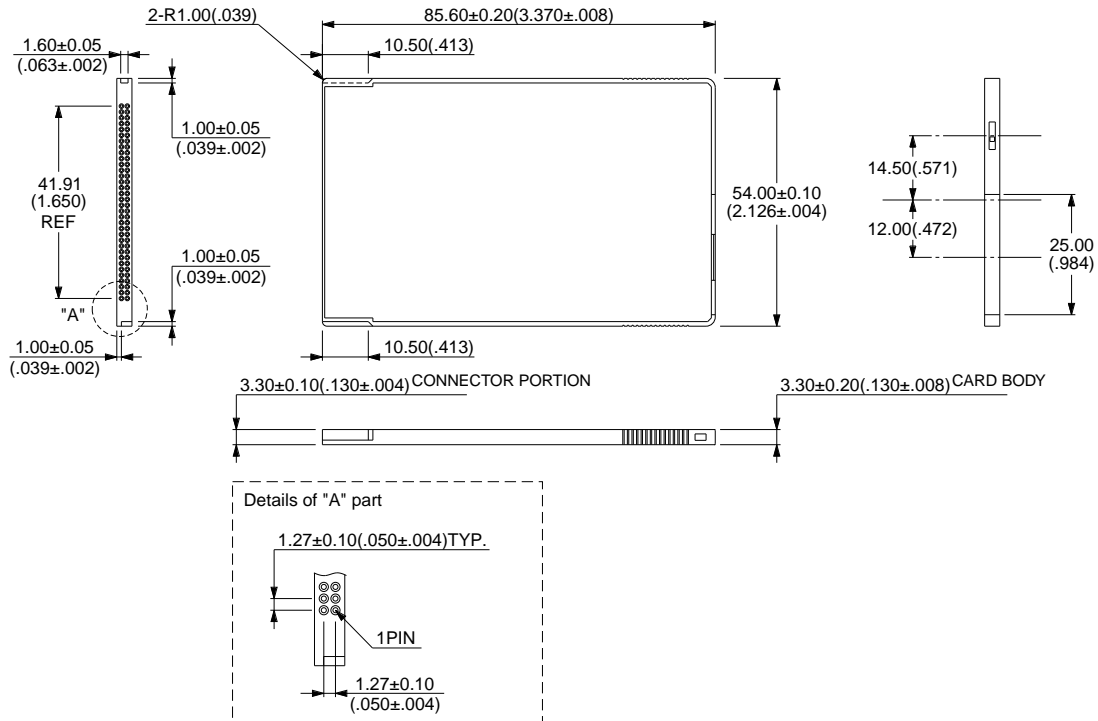

© 1994 FUJITSU LIMITED K68004SC-5-2

Dimensions in mm (inches)

■ DEVICE HANDLING PRECAUTIONS

This device is composed of fine electronic parts, so take care in handling or keeping it as below.

- The card is made fine, so do not keep it in the high temperature nor high humidity, place line in the direct sunshine nor near the heater.
- The card should not be bent, scratched, dropped nor be shocked violently.
- This device should never be taken a part. It could destroy the card or your personal computer hardware.
- To help you handle this device safely, request us the device specifications when purchasing this device.

MB98A9083x/9093x/9103x/9113x-20

FUJITSU LIMITED

For further information please contact:

Japan

FUJITSU LIMITED
Corporate Global Business Support Division
Electronic Devices
KAWASAKI PLANT, 4-1-1, Kamikodanaka
Nakahara-ku, Kawasaki-shi
Kanagawa 211-88, Japan
Tel: (044) 754-3763
Fax: (044) 754-3329

North and South America

FUJITSU MICROELECTRONICS, INC.
Semiconductor Division
3545 North First Street
San Jose, CA 95134-1804, U.S.A.
Tel: (408) 922-9000
Fax: (408) 432-9044/9045

Europe

FUJITSU MIKROELEKTRONIK GmbH
Am Siebenstein 6-10
63303 Dreieich-Buchsschlag
Germany
Tel: (06103) 690-0
Fax: (06103) 690-122

Asia Pacific

FUJITSU MICROELECTRONICS ASIA PTE. LIMITED
#05-08, 151 Lorong Chuan
New Tech Park
Singapore 556741
Tel: (65) 281-0770
Fax: (65) 281-0220

All Rights Reserved.

The contents of this document are subject to change without notice. Customers are advised to consult with FUJITSU sales representatives before ordering.

The information and circuit diagrams in this document presented as examples of semiconductor device applications, and are not intended to be incorporated in devices for actual use. Also, FUJITSU is unable to assume responsibility for infringement of any patent rights or other rights of third parties arising from the use of this information or circuit diagrams.

FUJITSU semiconductor devices are intended for use in standard applications (computers, office automation and other office equipment, industrial, communications, and measurement equipment, personal or household devices, etc.).

CAUTION:

Customers considering the use of our products in special applications where failure or abnormal operation may directly affect human lives or cause physical injury or property damage, or where extremely high levels of reliability are demanded (such as aerospace systems, atomic energy controls, sea floor repeaters, vehicle operating controls, medical devices for life support, etc.) are requested to consult with FUJITSU sales representatives before such use. The company will not be responsible for damages arising from such use without prior approval.

Any semiconductor devices have inherently a certain rate of failure. You must protect against injury, damage or loss from such failures by incorporating safety design measures into your facility and equipment such as redundancy, fire protection, and prevention of over-current levels and other abnormal operating conditions.

If any products described in this document represent goods or technologies subject to certain restrictions on export under the Foreign Exchange and Foreign Trade Control Law of Japan, the prior authorization by Japanese government should be required for export of those products from Japan.